

Central St.Giles Court



Il complesso di residenze e uffici sorge dove si trovava la sede dei servizi segreti britannici. Il disegno del complesso nasce dai vuoti lasciati dalla demolizione dell'edificio preesistente, risulta così disegnato un poliedro frastagliato a 22 facce. Lo spazio era complesso per la geometria del tessuto urbano, e quindi ne è nata una combinazione di facciate cangianti, ciascuna diversa in altezza, per orientamento, colore e rapporto con la luce. La massa è così alleggerita e frammentata, composta da tanti pezzi di colori differenti collegati tra loro. Le facciate si fermano da 4 a 6 metri da terra, così da rendere il luogo accessibile e trasparente, un invito a convergere nella piazza interna dove sono concentrati i negozi e le attività pubbliche.

Dati Progetto

Progettazione	2002 - 2006
Costruzione	2006 - 2010
Area del sito	7082 m2
Superficie costruita	Uffici: 39000 m2 (10 piani) Residenze: 8800 m2 (14 piani 109 appartamenti) Ristoranti, spazi commerciali al piano terra: 2137 m2 Piazza pubblica: 2044 m2

Credits

Cliente	Legal & General with Mitsubishi Estate Corporation Stanhope PLC
Architetto	Renzo Piano Building Workshop, architects in collaborazione con Fletcher Priest Architects (Londra)
Consulenti	Arup (structure and services); Davis Langdon (cost consultant); Bovis Lend Lease (pre-construction advice); Emmer Pfenninger & Partners (façades); P.Castiglioni / G.Bianchi (lighting); PRP (fit-out for affordable residential); Charles Funke Associates (landscaping)

Immagini



Soggetto	Ceramic bars production
Data	-
Codice Immagine	Sgi_334
Autore	-
Copyright	NBK and Schneider



Soggetto	Ceramic bars production
Data	-
Codice Immagine	Sgi_338
Autore	-
Copyright	NBK and Schneider



Soggetto	Mock-Up in Stimpfach
Data	2008/06
Codice Immagine	Sgi_127
Autore	Van der Staay, Maurits
Copyright	RPBW - Renzo Piano Building Workshop Architects



Soggetto	Mock-Up in Stimpfach
Data	2008/06/01
Codice Immagine	Sgi_134
Autore	Van der Staay, Maurits
Copyright	RPBW - Renzo Piano Building Workshop Architects



Soggetto	Panoramic view with the construction site on the background
Data	-
Codice Immagine	Sgi__348
Autore	Van der Staay, Maurits
Copyright	RPBW - Renzo Piano Building Workshop Architects



Soggetto	Aerial view of the construction site
Data	2008/11/19
Codice Immagine	Sgi_138
Autore	Molter, Philipp
Copyright	RPBW - Renzo Piano Building Workshop Architects



Soggetto	Construction site viewed from the groundfloor
Data	2008/11/19
Codice Immagine	Sgi_141
Autore	Van der Staay, Maurits
Copyright	RPBW - Renzo Piano Building Workshop Architects



Soggetto	Construction site. Detail of the steel joint.
Data	2008/11/19
Codice Immagine	Sgi_139
Autore	Van der Staay, Maurits
Copyright	RPBW - Renzo Piano Building Workshop Architects



Soggetto

Aerial view of the construction site

Data

2009/10/27

Codice Immagine

Sgi_198

Autore

Van der Staay, Maurits

Copyright

RPBW - Renzo Piano Building Workshop Architects



Soggetto	Construction site. Detail of the façade.
Data	2009
Codice Immagine	Sgi_429
Autore	Van der Staay, Maurits
Copyright	RPBW - Renzo Piano Building Workshop Architects



Soggetto	Constuction site. Detail of the cladding façade during the installation phase.
Data	-
Codice Immagine	Sgi_424
Autore	Van der Staay, Maurits
Copyright	RPBW - Renzo Piano Building Workshop Architects



Soggetto	Aerial view
Data	2010/05/01
Codice Immagine	Sgi_269
Autore	Denancé, Michel
Copyright	Denancé, Michel



Soggetto	Overall view
Data	2010/05/01
Codice Immagine	Sgi_279
Autore	Denancé, Michel
Copyright	Denancé, Michel



Soggetto	Exterior view of the façades
Data	2010/05/01
Codice Immagine	Sgi_345
Autore	-
Copyright	© Hufton & Crow, Courtesy L&G and MEC



Soggetto	Detail of the building corner
Data	2009
Codice Immagine	Sgi_351
Autore	Van der Staay, Maurits
Copyright	RPBW - Renzo Piano Building Workshop Architects



Soggetto	Exterior view of the façades
Data	2009
Codice Immagine	Sgi_369
Autore	Van der Staay, Maurits
Copyright	RPBW - Renzo Piano Building Workshop Architects



Soggetto	View of the "piazza"
Data	2010/06/01
Codice Immagine	Sgi_258
Autore	Denancé, Michel
Copyright	Denancé, Michel



Soggetto View of the "piazza"

Data 2010/06/01

Codice Immagine Sgi__238

Autore Denancé, Michel

Copyright Denancé, Michel



Soggetto	The lobby
Data	2010/06/01
Codice Immagine	Sgi__240
Autore	Denancé, Michel
Copyright	Denancé, Michel



Soggetto	Detail view of the lobby staircase handrail
Data	2010/04/23
Codice Immagine	Sgi_358
Autore	Van der Staay, Maurits
Copyright	RPBW - Renzo Piano Building Workshop Architects



Soggetto Interior view

Data 2010/05/01

Codice Immagine Sgi_282

Autore Denancé, Michel

Copyright Denancé, Michel



Soggetto	Detail of the façade
Data	2010/05/01
Codice Immagine	Sgi__276
Autore	Denancé, Michel
Copyright	Denancé, Michel



Soggetto	Detail of the winter garden façade
Data	2010/05/01
Codice Immagine	Sgi_275
Autore	Denancé, Michel
Copyright	Denancé, Michel



Soggetto	Detail view of a winter garden façade joint
Data	2010/01/26
Codice Immagine	Sgi_380
Autore	Van der Staay, Maurits
Copyright	RPBW - Renzo Piano Building Workshop Architects



Soggetto	Exterior view of the winter garden façade
Data	2010/04/28
Codice Immagine	Sgi_352
Autore	Van der Staay, Maurits
Copyright	RPBW - Renzo Piano Building Workshop Architects



Soggetto	The garden on top of the building
Data	2010/04/23
Codice Immagine	Sgi_353
Autore	Van der Staay, Maurits
Copyright	RPBW - Renzo Piano Building Workshop Architects



Soggetto	The roof terrace
Data	2009/12/10
Codice Immagine	Sgi_219
Autore	Van der Staay, Maurits
Copyright	RPBW - Renzo Piano Building Workshop Architects

Disegni

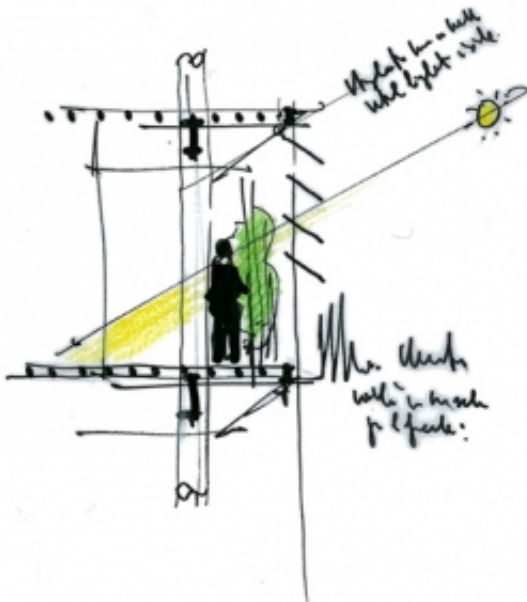

Titolo	-
Scala	-
Dimensione	A4
Data	(2008/04)
Numero Disegno	-

Codice disegno	SGL-rp_039
----------------	------------

Autore	Renzo Piano
--------	-------------

Copyright	Renzo Piano
-----------	-------------

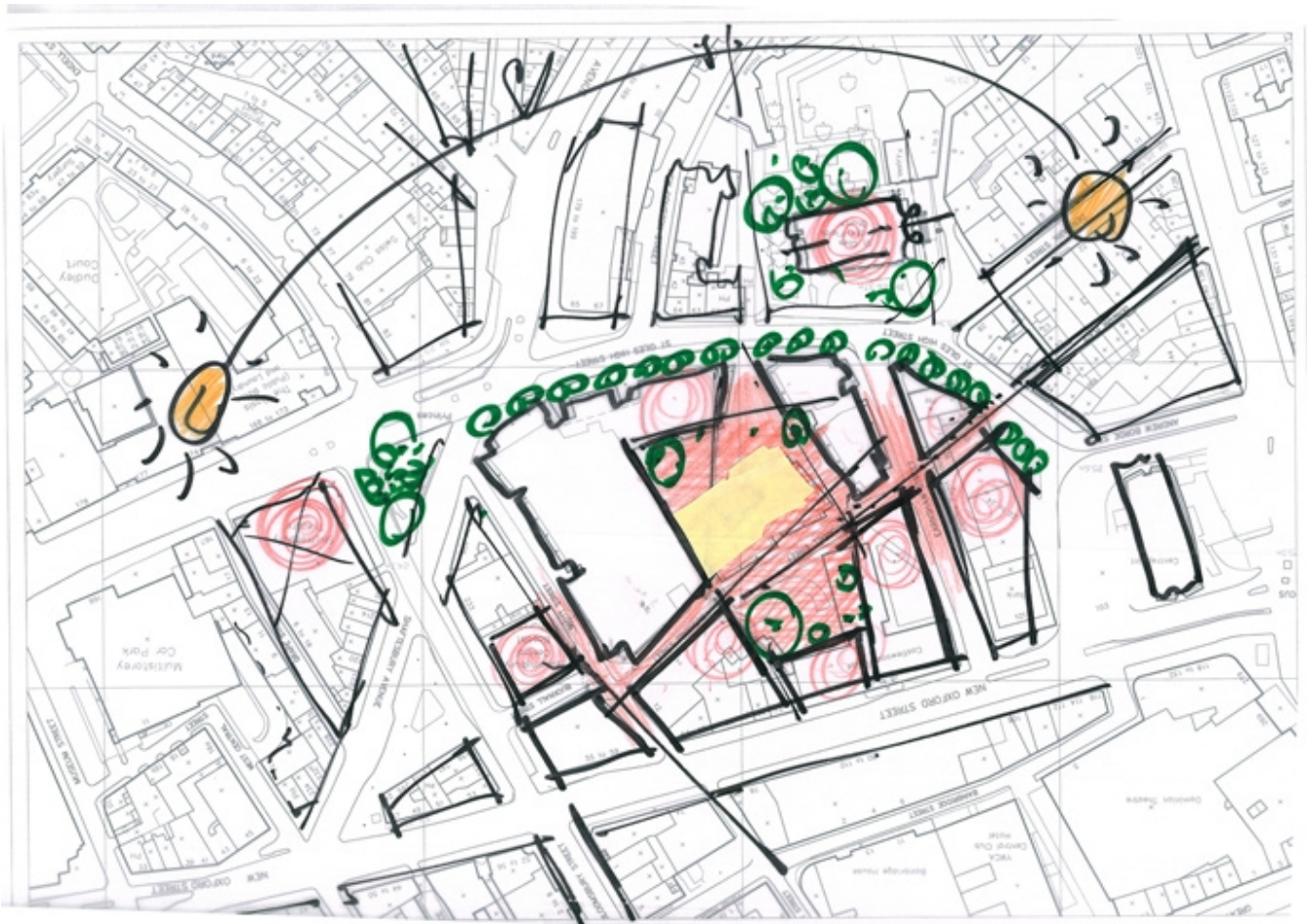

Titolo	-
Scala	-
Dimensione	A3
Data	2007/04/27
Numero Disegno	-
Codice disegno	SGI-rp_032
Autore	Renzo Piano
Copyright	Renzo Piano

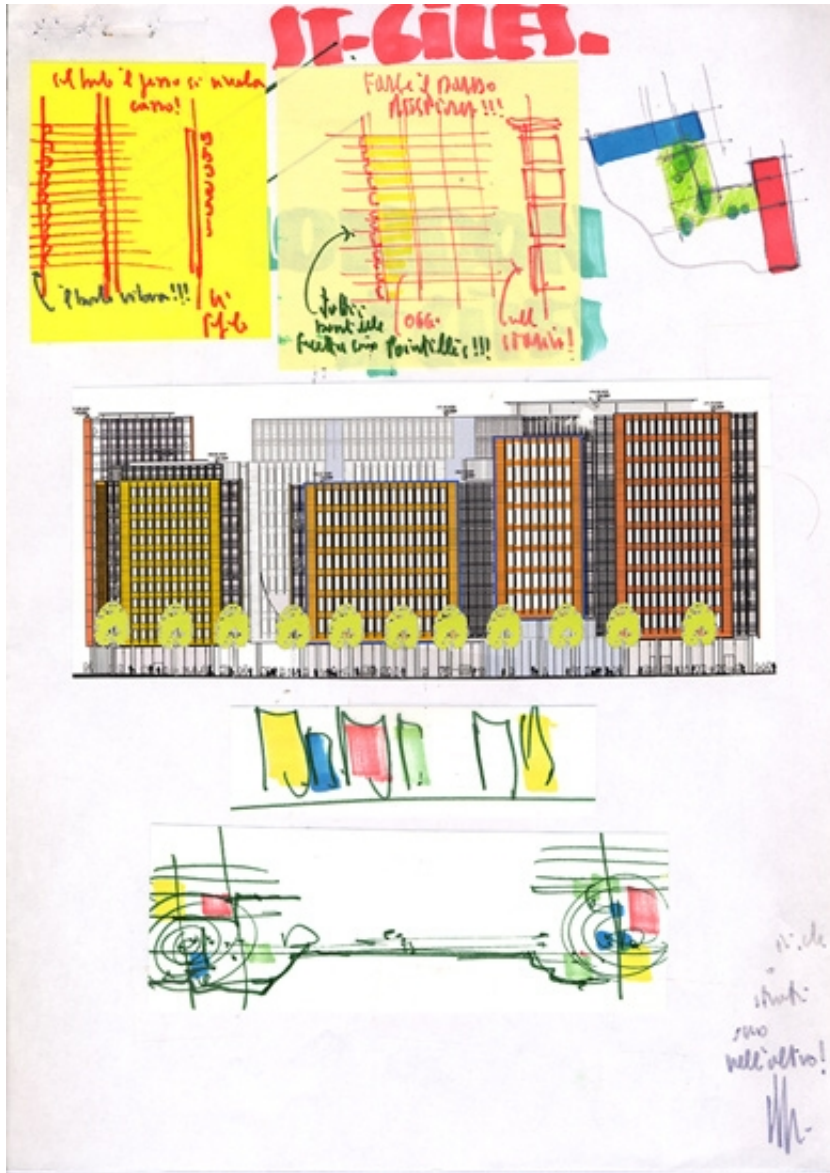

Titolo	St. Giles
Scala	-
Dimensione	A4
Data	(2007)
Numero Disegno	-
Codice disegno	SGL-rp_016

Autore	Renzo Piano
--------	-------------

Copyright	Renzo Piano
-----------	-------------

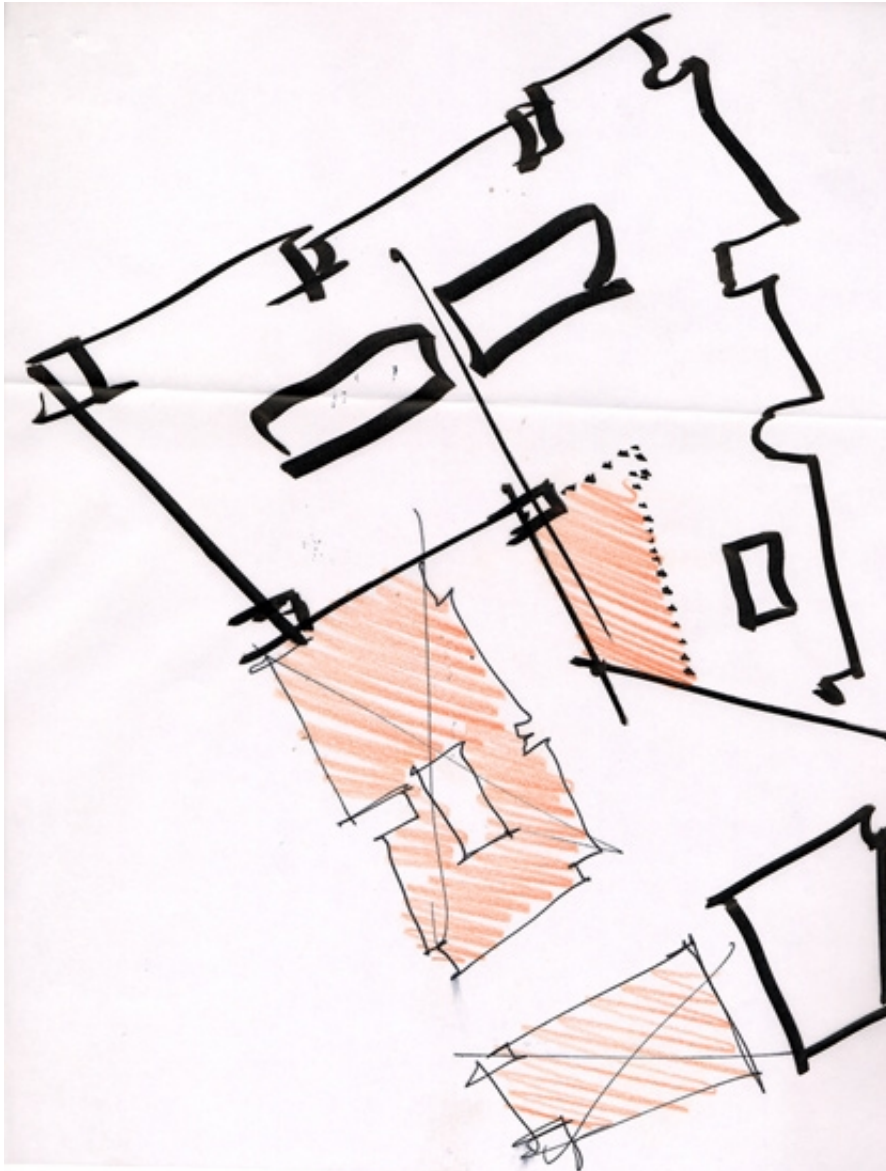

Titolo	-
Scala	-
Dimensione	A4
Data	2007/02/20
Numero Disegno	-
Codice disegno	SGL-rp_022

Autore	Renzo Piano
--------	-------------

Copyright	Renzo Piano
-----------	-------------

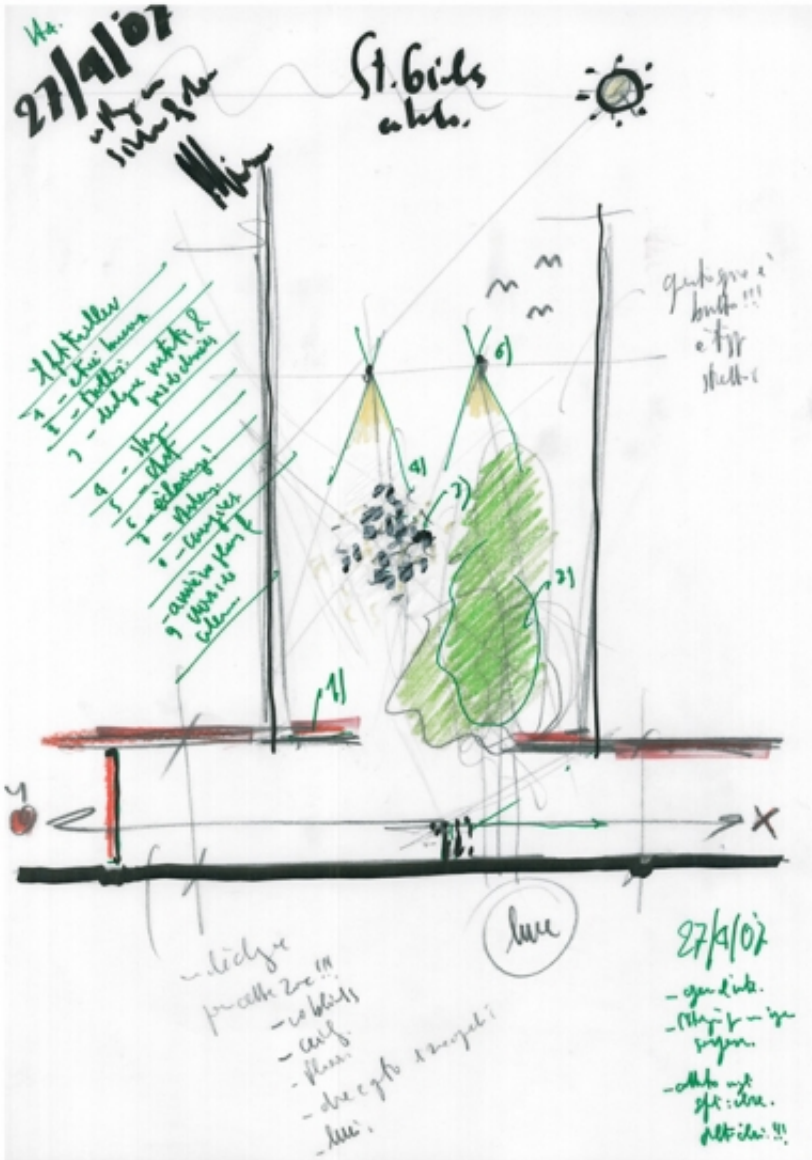

Titolo	St. Giles a Londra
Scala	-
Dimensione	A3
Data	2007/04/27
Numero Disegno	-
Codice disegno	SGL-rp_028

Autore	Renzo Piano
--------	-------------

Copyright	Renzo Piano
-----------	-------------

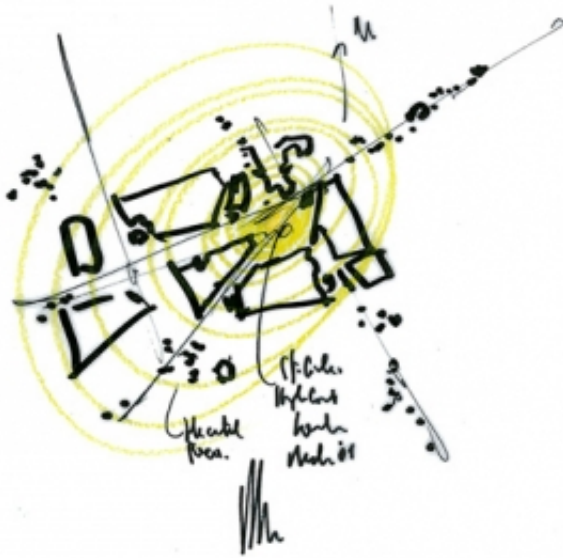

Titolo	-
Scala	-
Dimensione	A4
Data	2001/03
Numero Disegno	-
Codice disegno	SGL-rp_036

Autore	Renzo Piano
--------	-------------

Copyright	Renzo Piano
-----------	-------------

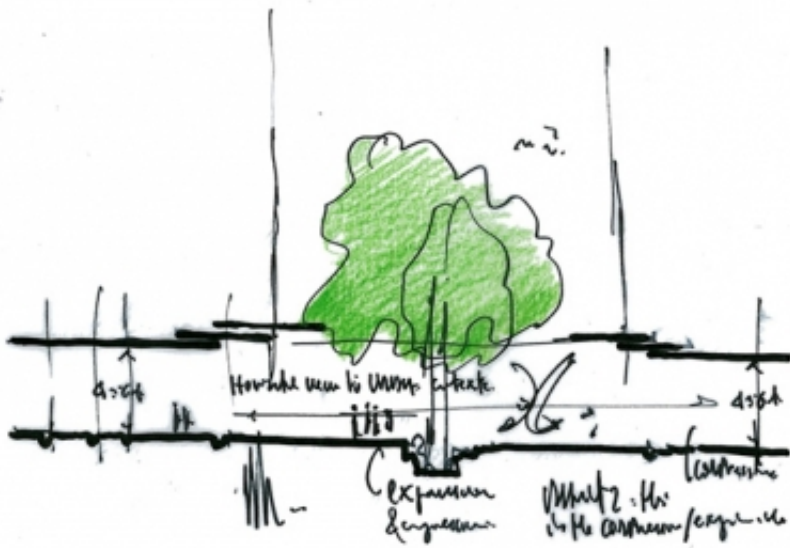

Titolo	-
Scala	-
Dimensione	A4
Data	2008/04
Numero Disegno	-
Codice disegno	SGI-rp_037

Autore	Renzo Piano
--------	-------------

Copyright	Renzo Piano
-----------	-------------

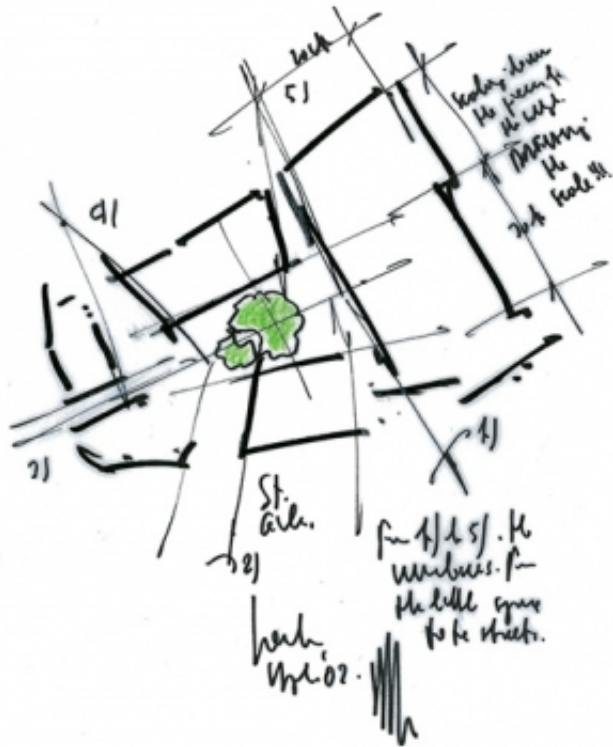

Titolo	-
Scala	-
Dimensione	A4
Data	2008/04
Numero Disegno	-
Codice disegno	SGI-rp_040

Autore	Renzo Piano
--------	-------------

Copyright	Renzo Piano
-----------	-------------

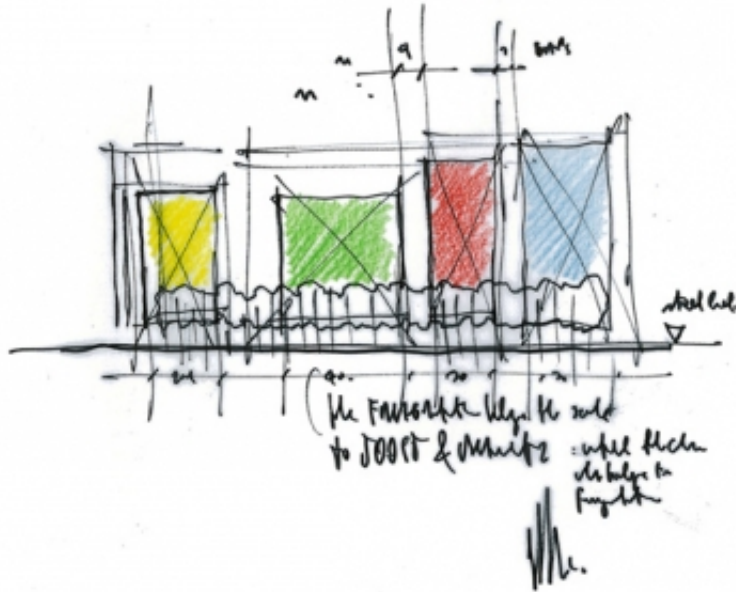

Titolo	-
Scala	-
Dimensione	A4
Data	2008/04
Numero Disegno	-
Codice disegno	SGI-rp_038

Autore	Renzo Piano
--------	-------------

Copyright	Renzo Piano
-----------	-------------

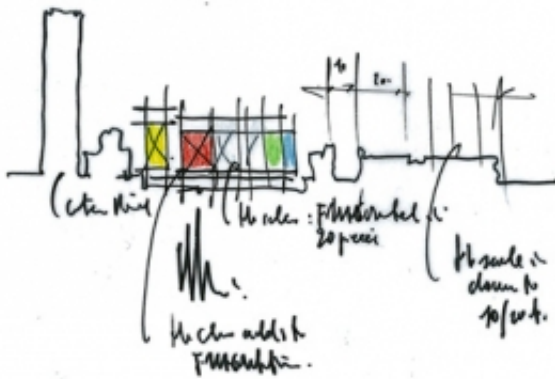

Titolo	-
Scala	-
Dimensione	17,30x14,10 cm
Data	2008/04
Numero Disegno	-
Codice disegno	SGI-rp_041

Autore	Renzo Piano
--------	-------------

Copyright	Renzo Piano
-----------	-------------

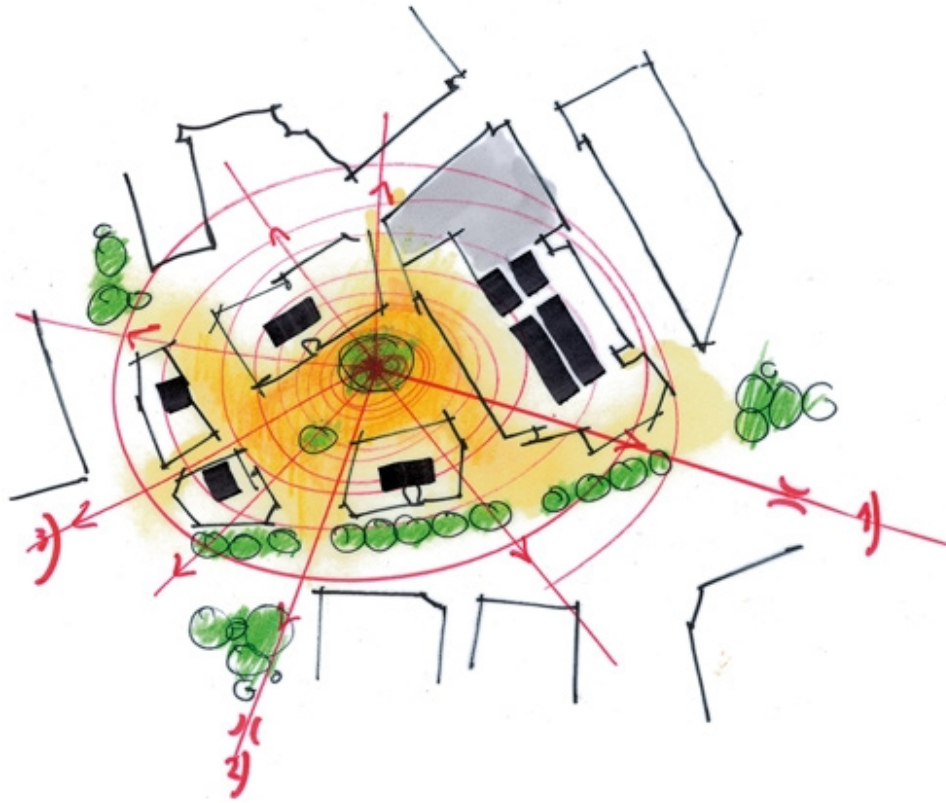

Titolo	-
Scala	-
Dimensione	54x42 cm
Data	2006/10
Numero Disegno	-
Codice disegno	SGL_E_008
Autore	Joost Moolhuijzen/Renzo Piano Building Workshop
Copyright	Renzo Piano Building Workshop



Titolo	Sketch section piazza
Scala	-
Dimensione	76,95x44 cm
Data	2006
Numero Disegno	-
Codice disegno	SGI_E_004
Autore	Joost Moolhuijzen/Renzo Piano Building Workshop
Copyright	Renzo Piano Building Workshop

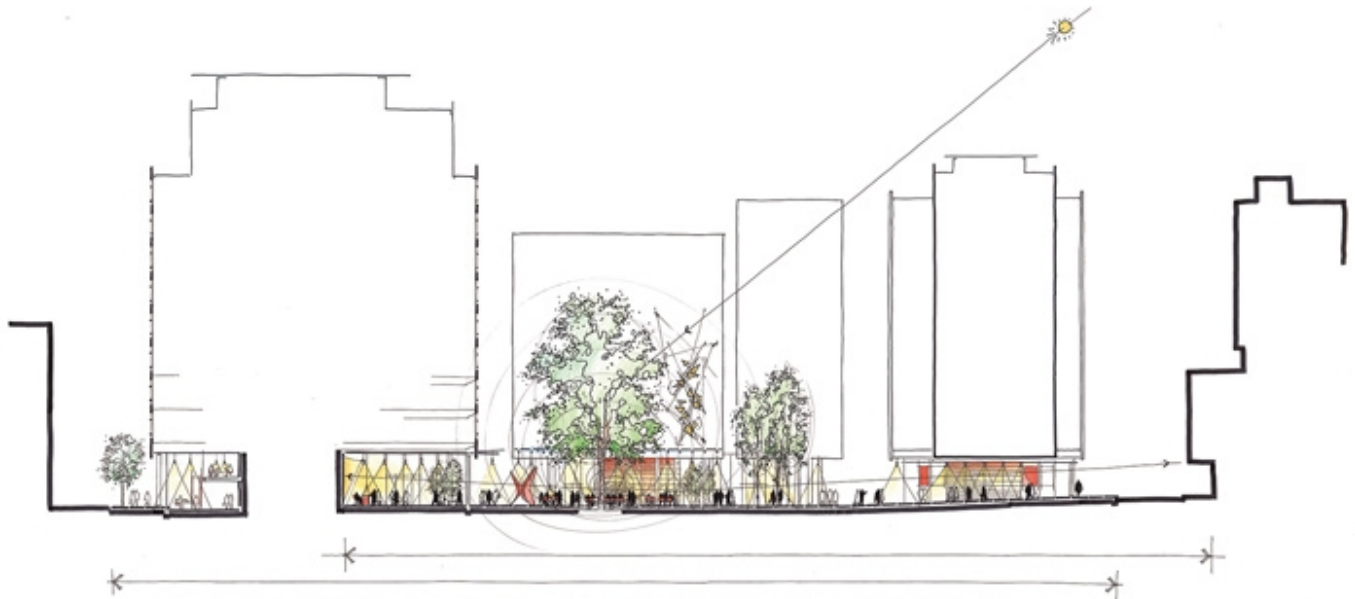

Titolo	Sketch section piazza
Scala	-
Dimensione	79,54x43 cm
Data	2006
Numero Disegno	-
Codice disegno	SGI_E_003
Autore	Joost Moolhuijzen/Renzo Piano Building Workshop
Copyright	Renzo Piano Building Workshop

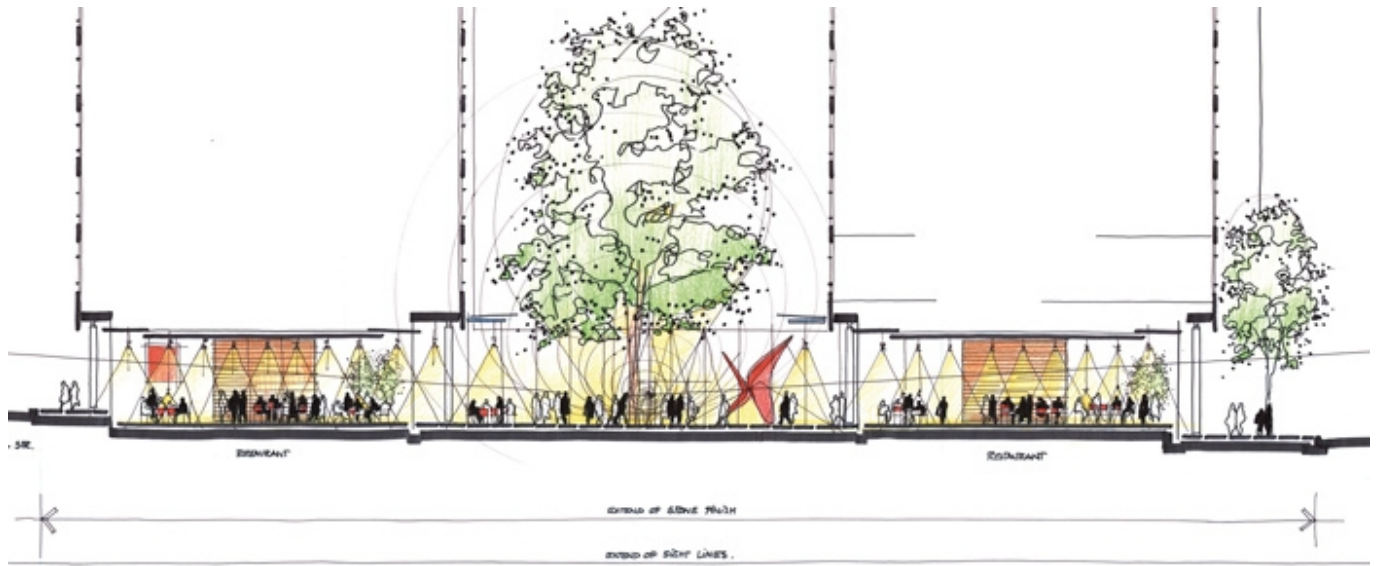

Titolo	Sketch section piazza
Scala	-
Dimensione	40x17 cm
Data	2006
Numero Disegno	-
Codice disegno	SGI_E_007
Autore	Joost Moolhuijzen/Renzo Piano Building Workshop
Copyright	Renzo Piano Building Workshop

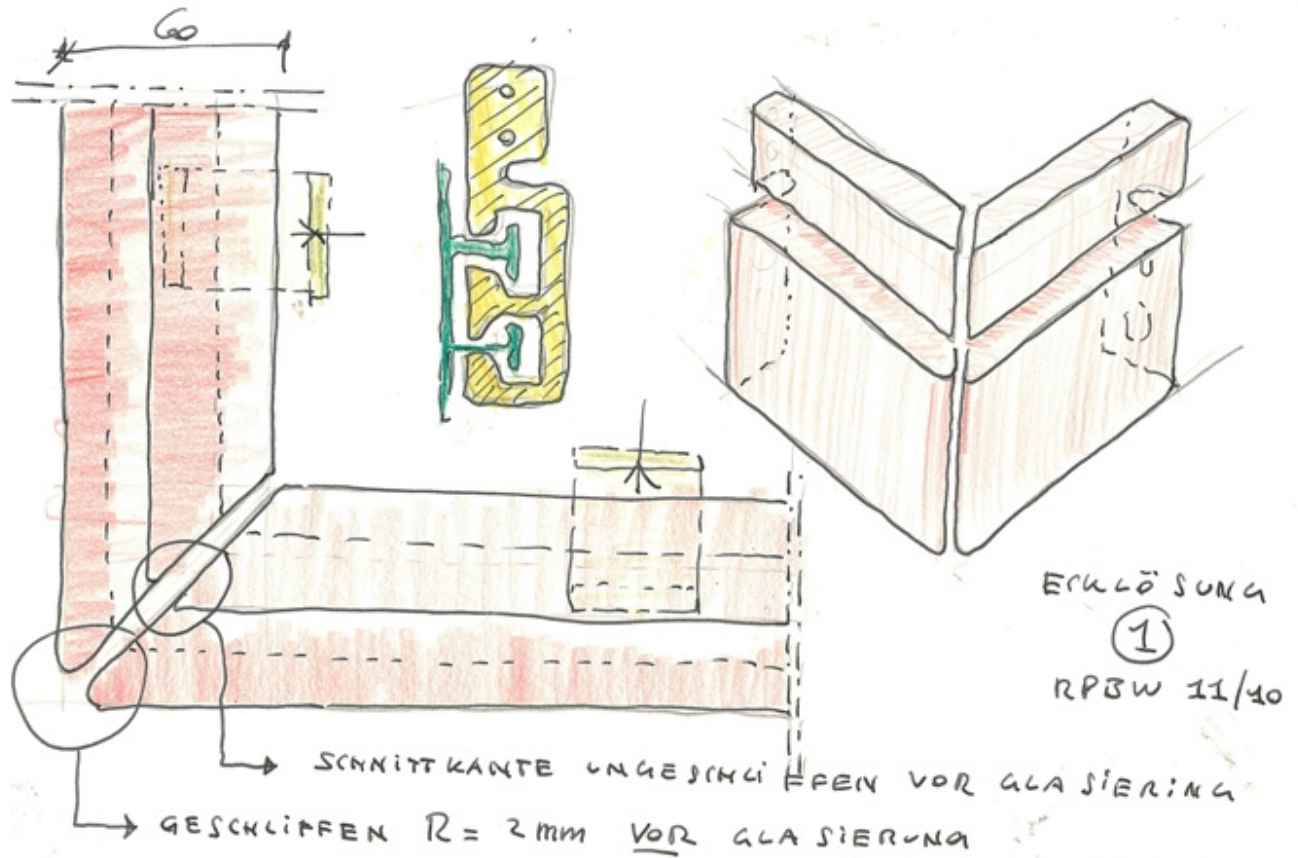

Titolo	(Sketch detail facade element)
Scala	-
Dimensione	28,15x18,97 cm
Data	2006/10
Numero Disegno	-
Codice disegno	SGI_E_006
Autore	Renzo Piano Building Workshop
Copyright	Renzo Piano Building Workshop

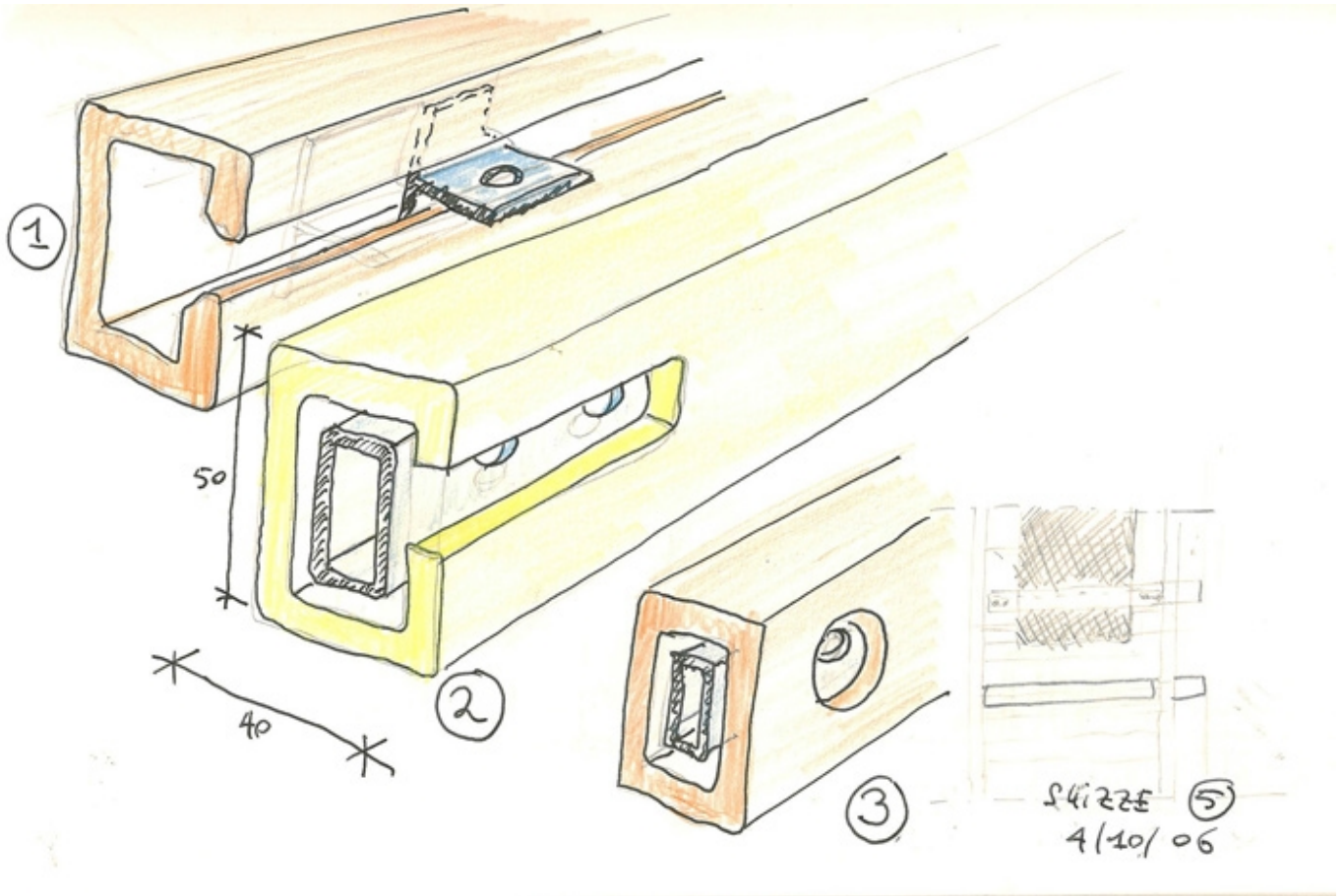

Titolo	(Sketch detail facade element)
Scala	-
Dimensione	28,77x19,24 cm
Data	2006/10
Numero Disegno	-
Codice disegno	SGI_E_005
Autore	Renzo Piano Building Workshop
Copyright	Renzo Piano Building Workshop



Titolo	Site plan - First ideas
Scala	-
Data	-
Numero Disegno	-
Codice disegno	SGI_DW_436
Autore	Renzo Piano Building Workshop

Copyright

Renzo Piano Building Workshop

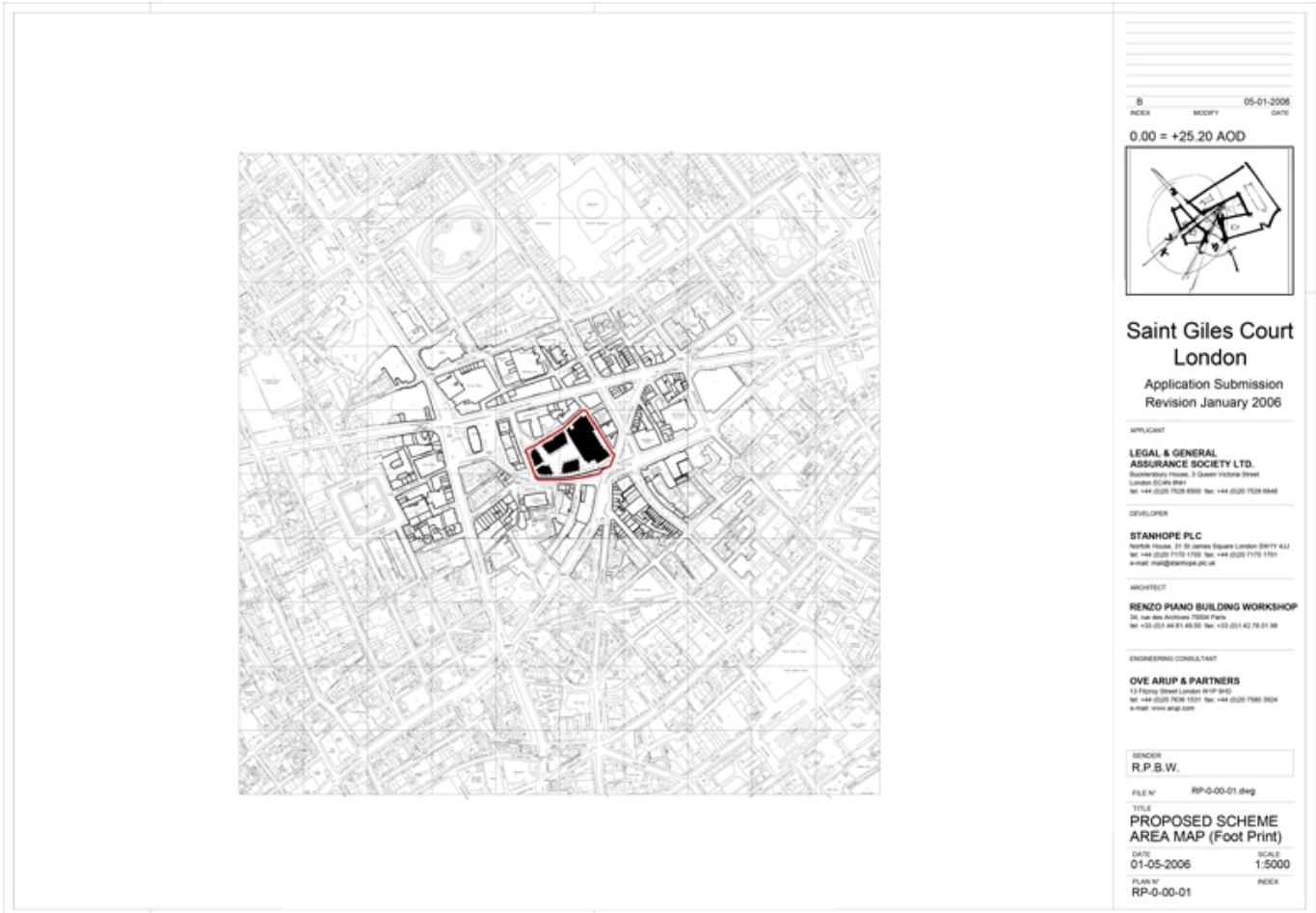

Titolo Proposed scheme area map

Scala 1:5000

Data 2006/05/01

Numero Disegno RP-0-00-01

Codice disegno SGI_DW_441

Autore Renzo Piano Building Workshop

Copyright Renzo Piano Building Workshop



Titolo	Proposed scheme ground floor plan
Scala	1:500
Data	2006/03/09
Numero Disegno	RP-1-00-ST
Codice disegno	SGI_DW_442
Autore	Renzo Piano Building Workshop
Copyright	Renzo Piano Building Workshop



Titolo	Proposed scheme typical floor plan
Scala	1:500
Data	2006/03/09
Numero Disegno	RP-1-00-TP
Codice disegno	SGI_DW_443
Autore	Renzo Piano Building Workshop
Copyright	Renzo Piano Building Workshop

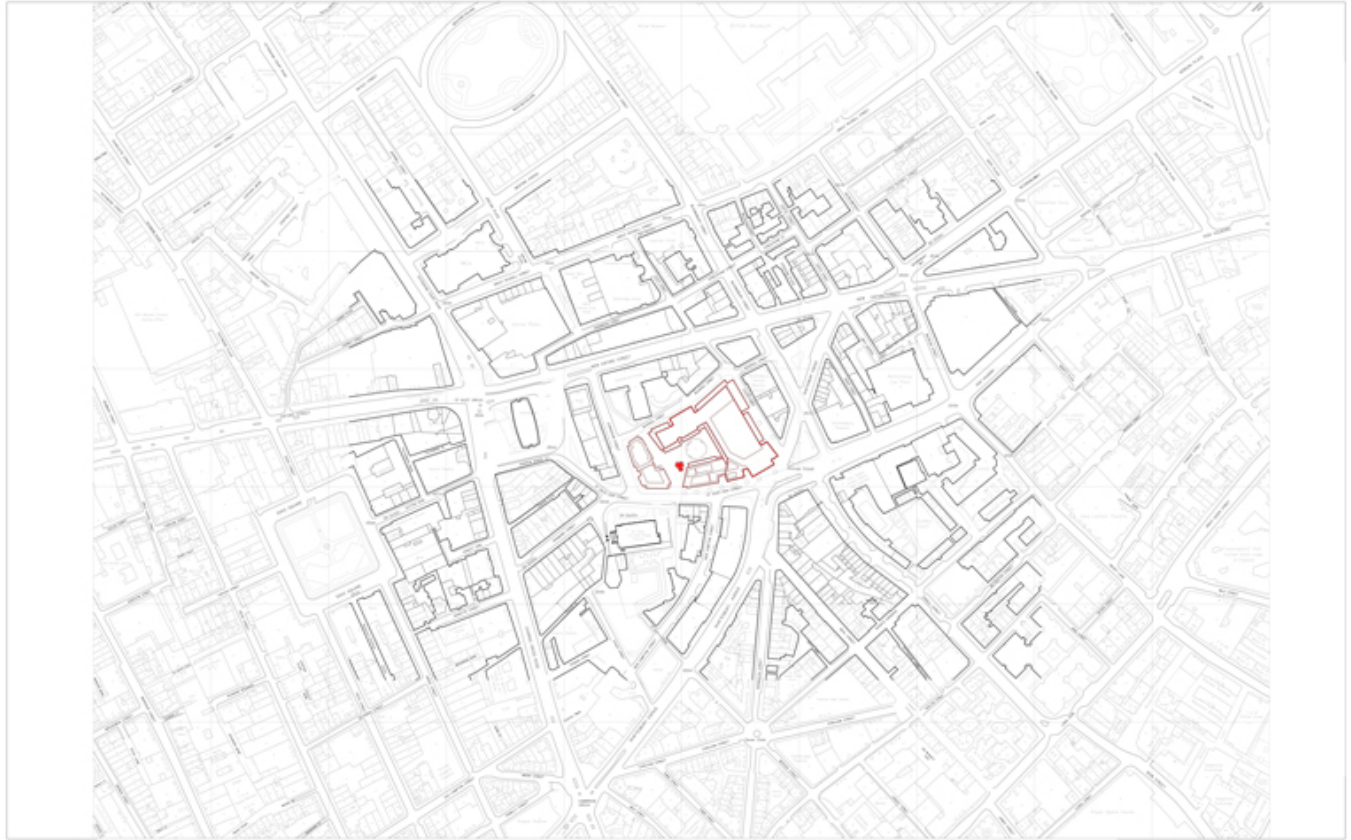

St.Giles - London
Areal Map 1/1000

RPBW - FPA
June 2007

Titolo	Areal map
Scala	1:1000
Data	07/2006
Numero Disegno	-
Codice disegno	SGI_DW_434
Autore	Renzo Piano Building Workshop
Copyright	Renzo Piano Building Workshop

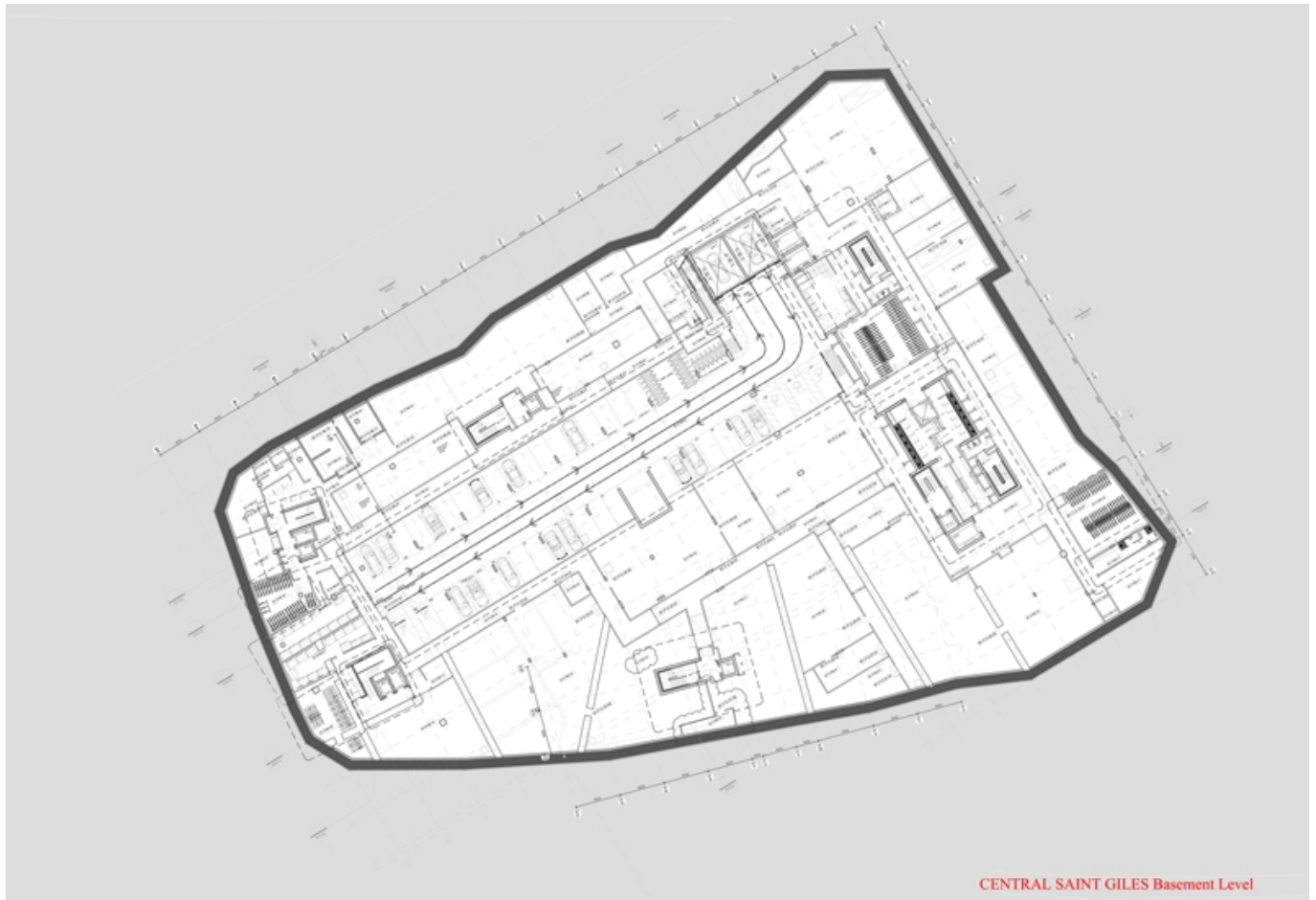

Titolo	Basement floor plan
Scala	1:200
Data	2010/05/22
Numero Disegno	-
Codice disegno	SGI_DW_433
Autore	Renzo Piano Building Workshop
Copyright	Renzo Piano Building Workshop



Titolo	Public area plan
Scala	1:100
Data	2010/05/22
Numero Disegno	-
Codice disegno	SGI_DW_001
Autore	Renzo Piano Building Workshop

Copyright

Renzo Piano Building Workshop



Titolo	Typical floor L2-07
Scala	N/A
Data	2010/05/19
Numero Disegno	-
Codice disegno	SGI_DW_004
Autore	Renzo Piano Building Workshop
Copyright	Renzo Piano Building Workshop

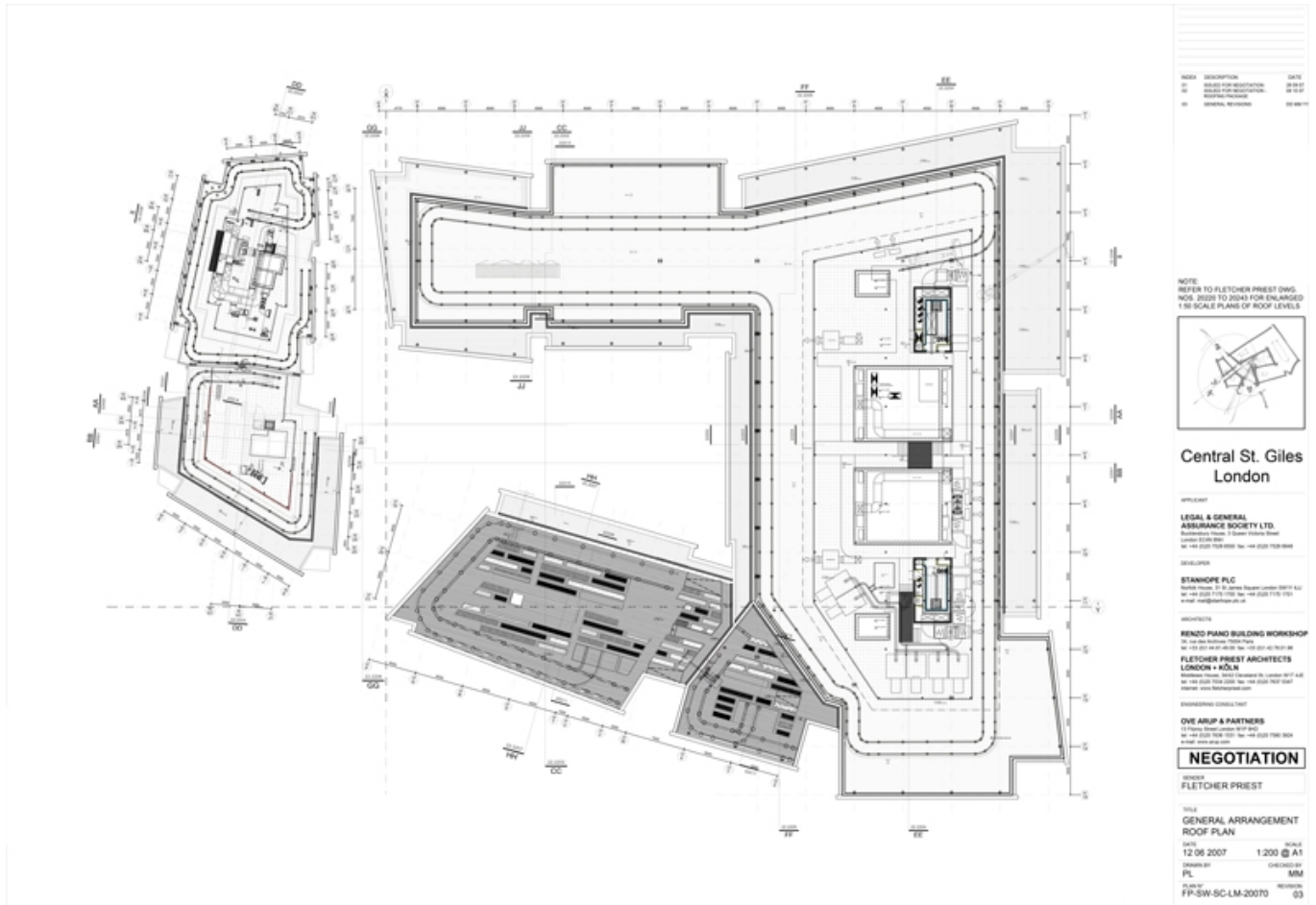

Titolo	General arrangement roof plan
Scala	1:200
Data	2007/10/08
Numero Disegno	FP-SW-SC-LM-20070
Codice disegno	SGI_DW_440
Autore	Renzo Piano Building Workshop
Copyright	Renzo Piano Building Workshop

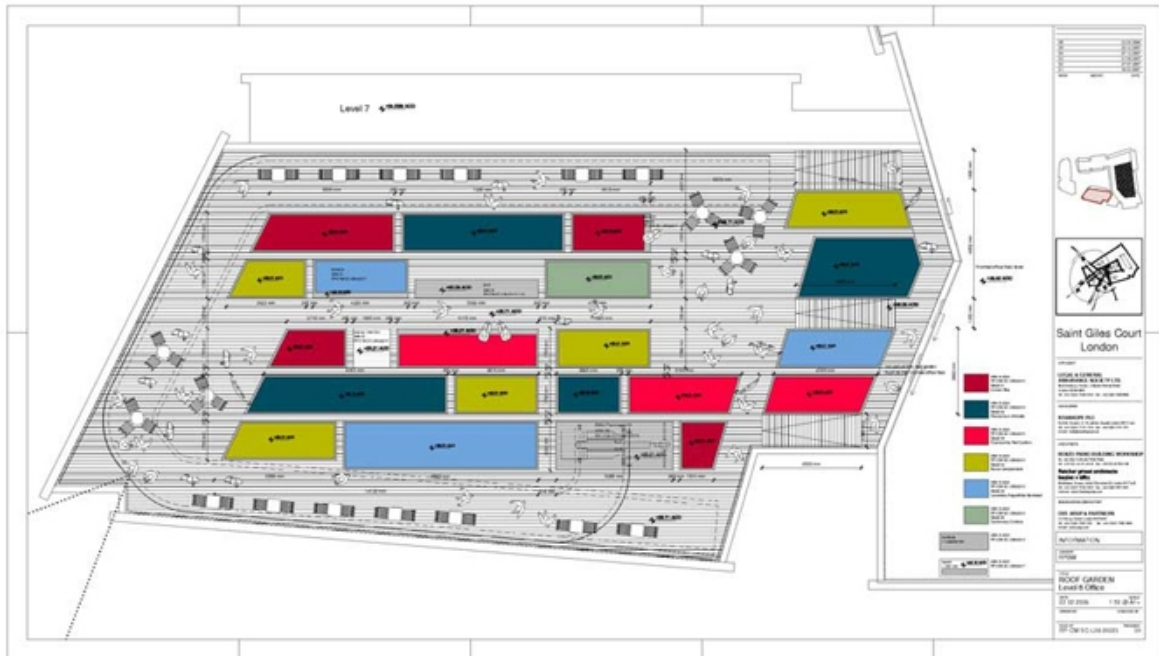

Titolo	Roof garden level 8 office
Scala	1:50
Data	2008/02/22
Numero Disegno	RP-CM-SC-L08-20023
Codice disegno	SGI_DW_250
Autore	Renzo Piano Building Workshop
Copyright	Renzo Piano Building Workshop

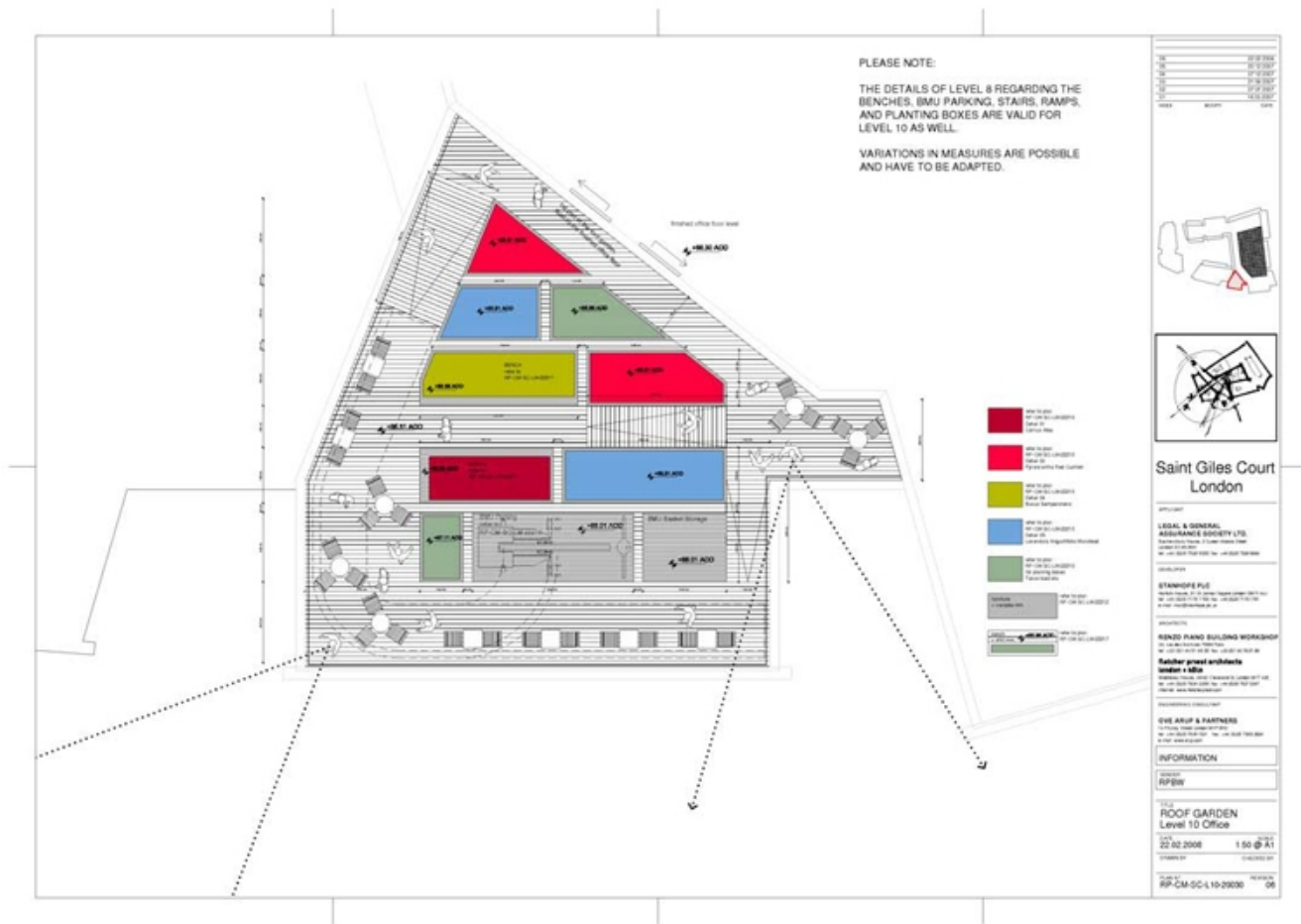

Titolo	Roof garden level 10 office
Scala	1:50
Data	2008/02/22
Numero Disegno	RP-CM-SC-L10-20030
Codice disegno	SGI_DW_251
Autore	Renzo Piano Building Workshop
Copyright	Renzo Piano Building Workshop

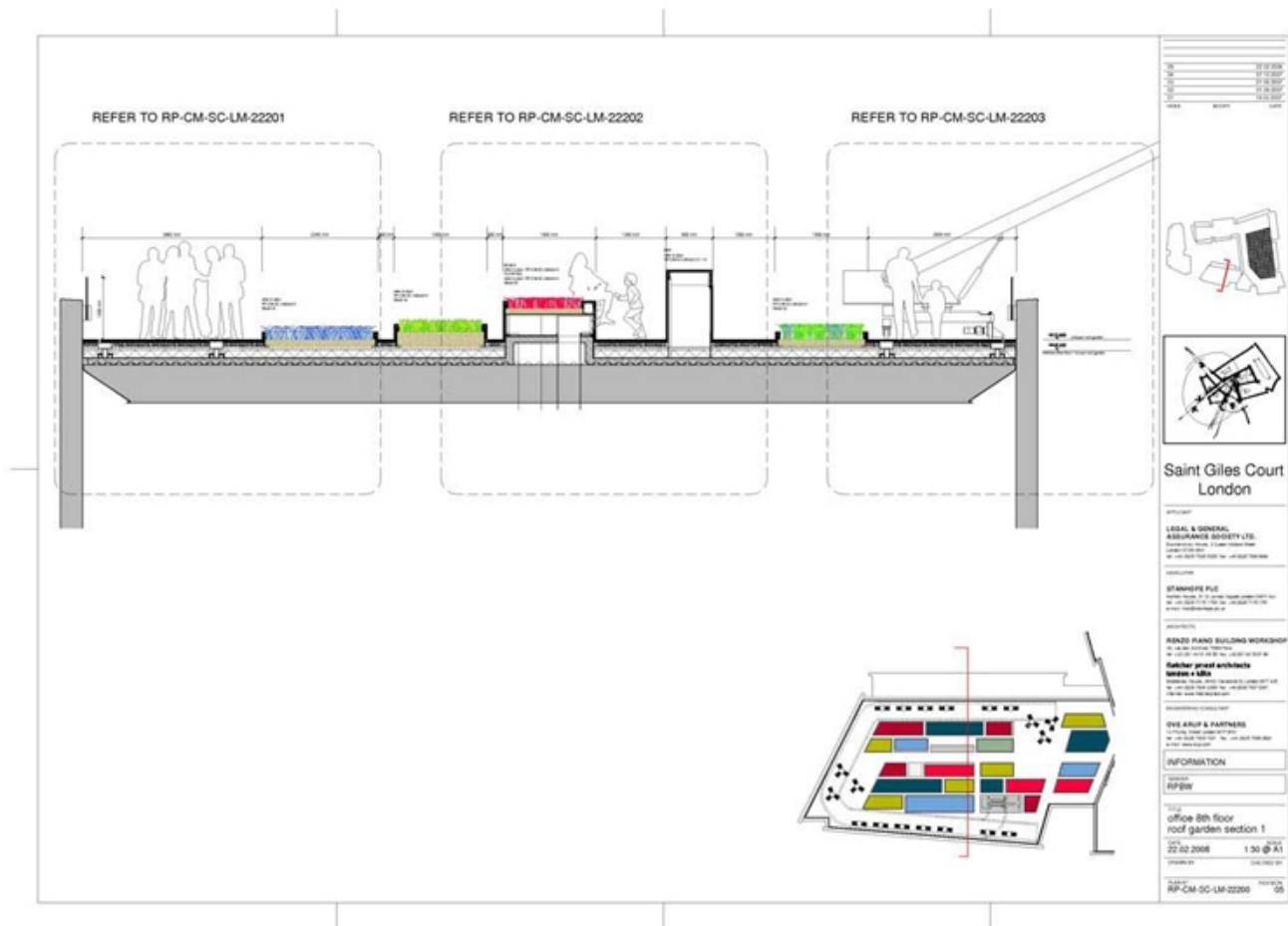

Titolo	Office 8th floor roof garden section 1
Scala	1:30
Data	2008/02/22
Numero Disegno	RP-CM-SC-LM-22200
Codice disegno	SGL_DW_252
Autore	Renzo Piano Building Workshop
Copyright	Renzo Piano Building Workshop

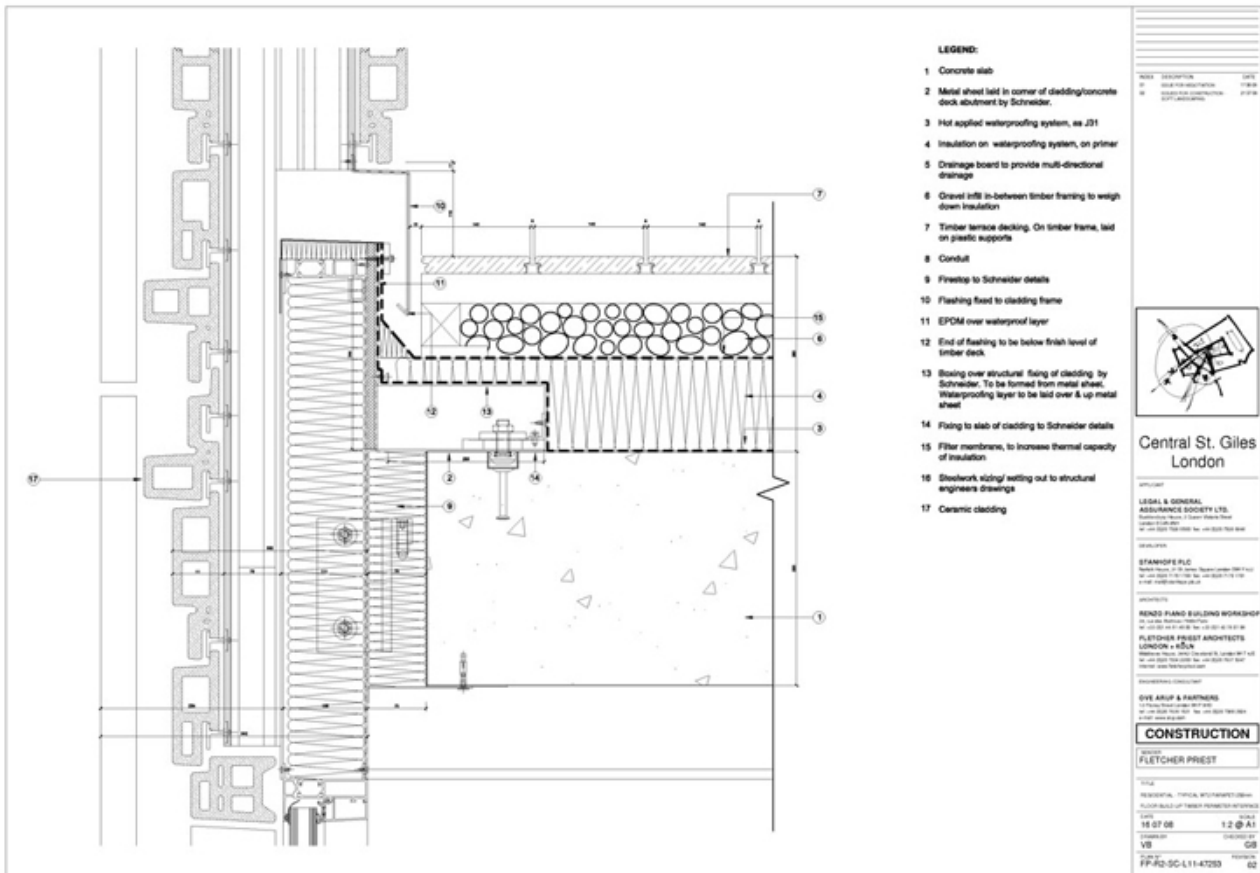

Titolo	Residential - Typical WT2 parapet/ 250 mm floor build up timber perimeter interface
Scala	1:2
Data	2008/07/21
Numero Disegno	FP-R2-SC-L11-47253
Codice disegno	SGI_DW_249
Autore	Fletcher Priest Architects
Copyright	Renzo Piano Building Workshop

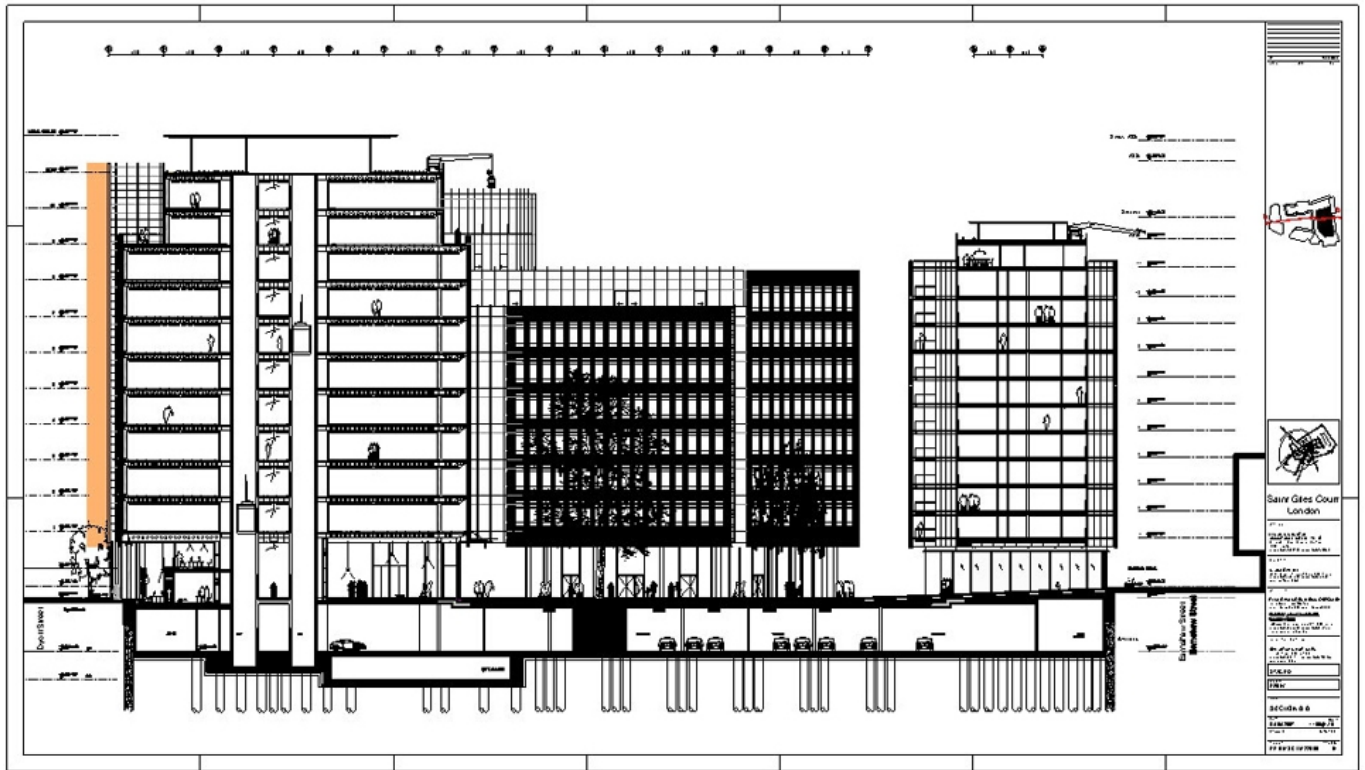

Titolo

Section B-B

Scala

1:100

Data

2007/06/06

Numero Disegno

RP-BM-SC-LM-22001

Codice disegno

SGI_DW_017

Autore

Renzo Piano Building Workshop

Copyright

Renzo Piano Building Workshop



Titolo	Big tree
Scala	1:50
Data	2008/03
Numero Disegno	-
Codice disegno	SGI_DW_437
Autore	Renzo Piano Building Workshop
Copyright	Renzo Piano Building Workshop

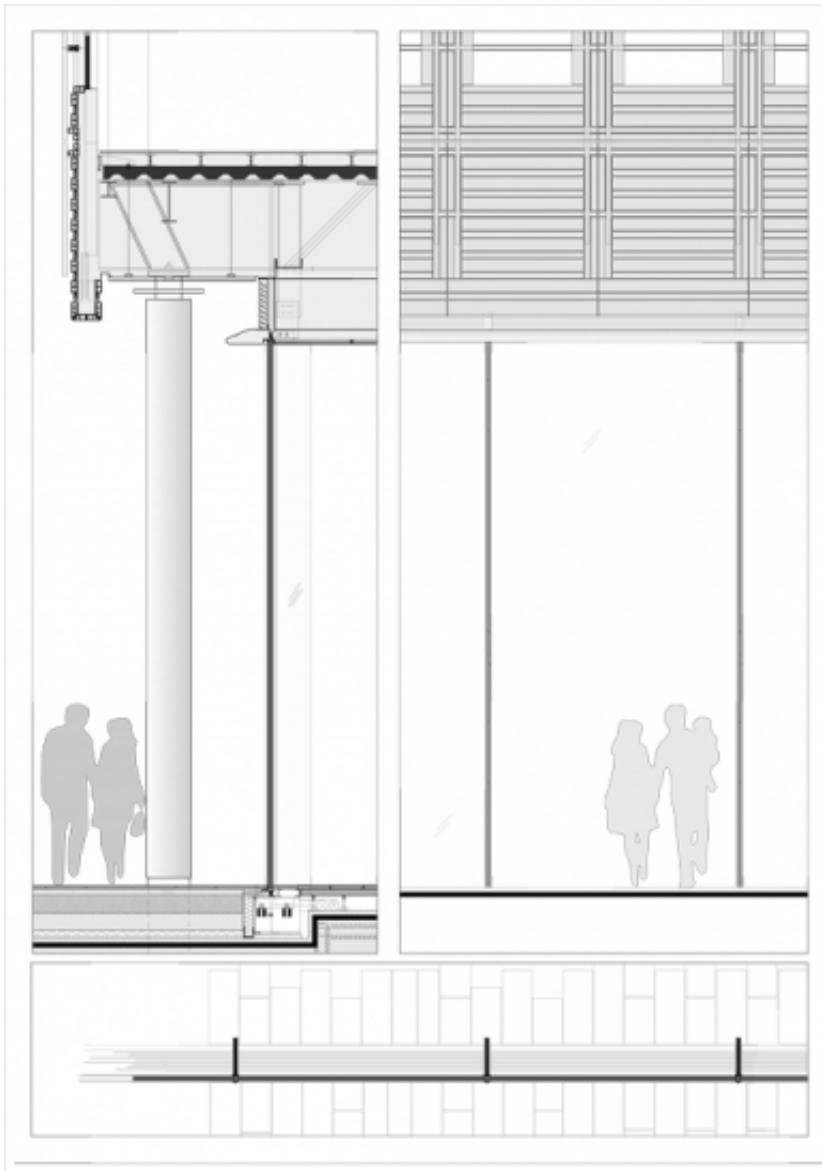

Titolo	Section groundfloor
Scala	1:10
Data	2010/03/06
Numero Disegno	-
Codice disegno	SGI_DW_445
Autore	Renzo Piano Building Workshop

Copyright

Renzo Piano Building Workshop

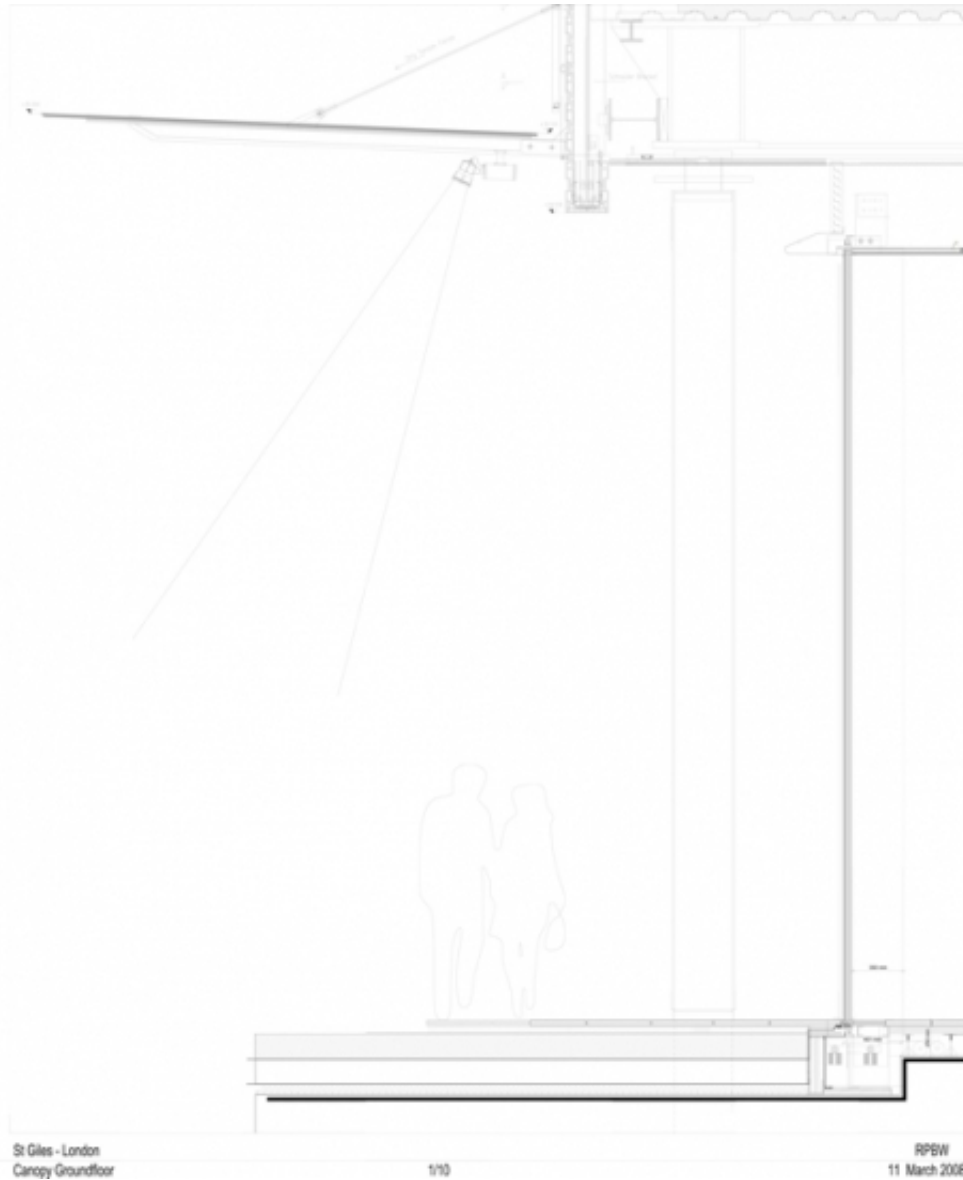

Titolo	Canopy Groundfloor
Scala	1:10
Data	2008/03/11
Numero Disegno	-
Codice disegno	SGI_DW_438
Autore	Renzo Piano Building Workshop

Copyright

Renzo Piano Building Workshop

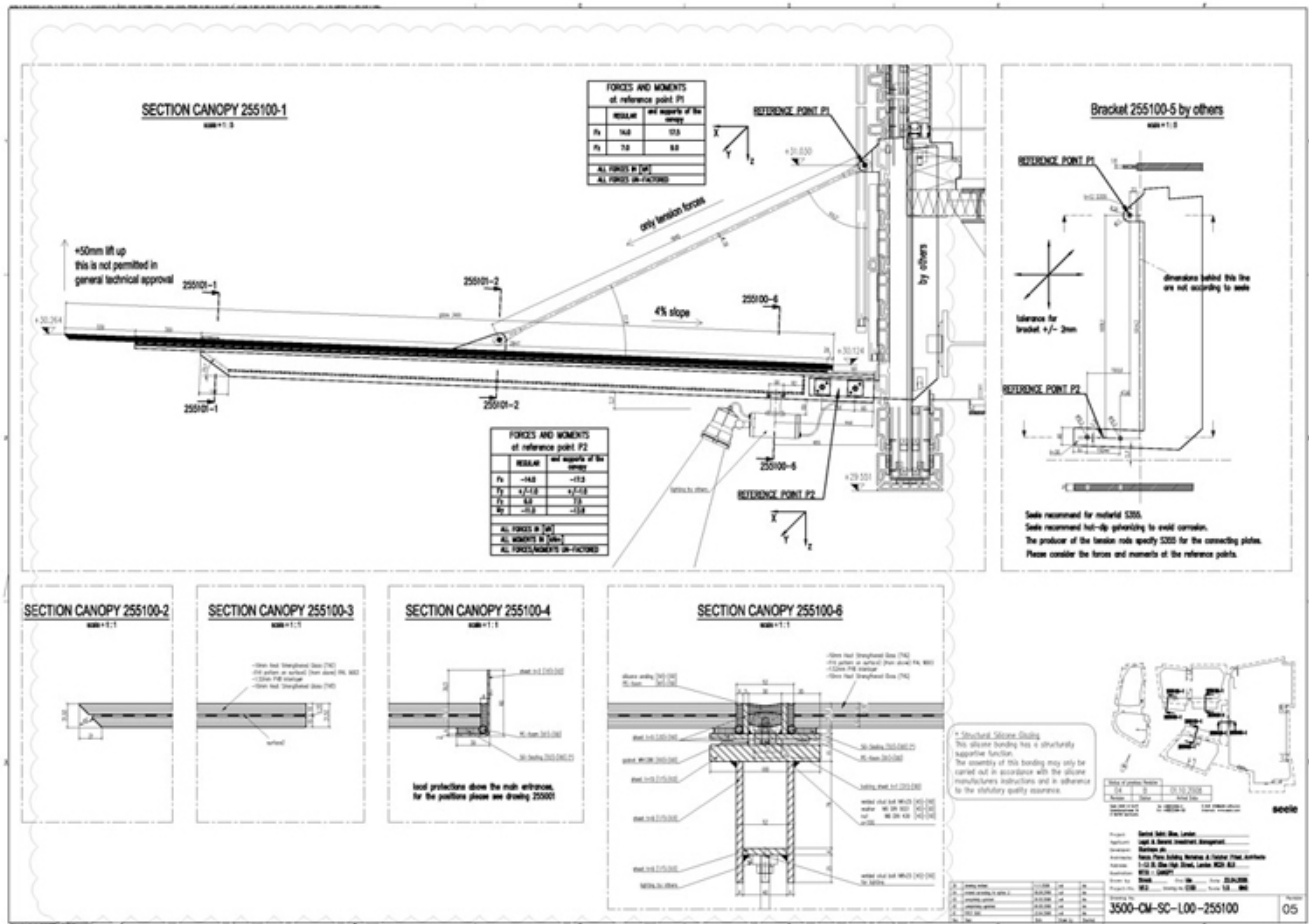

Titolo WT19 - Canopy

Scala 1:5

Data 2008/11/11

Numero Disegno 3500-CM-SC-L00-255100

Codice disegno SGI_DW_192

Autore Seele GmbH & Co

Copyright Seele GmbH & Co

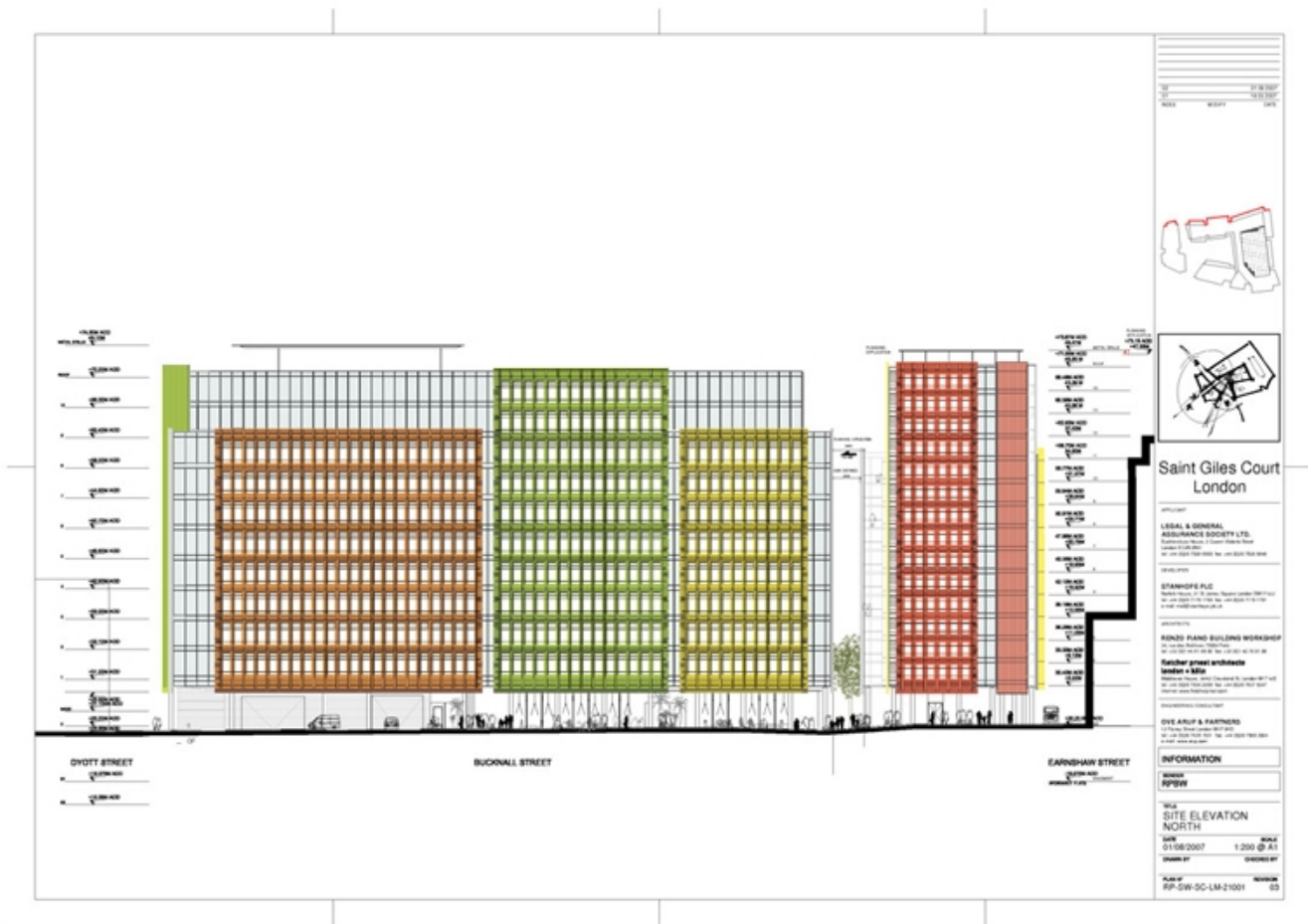

Titolo	Site Elevation North
Scala	1:200
Data	2007/09/01
Numero Disegno	RP-SW-SC-LM-21001
Codice disegno	SGI_DW_011
Autore	Renzo Piano Building Workshop
Copyright	Renzo Piano Building Workshop

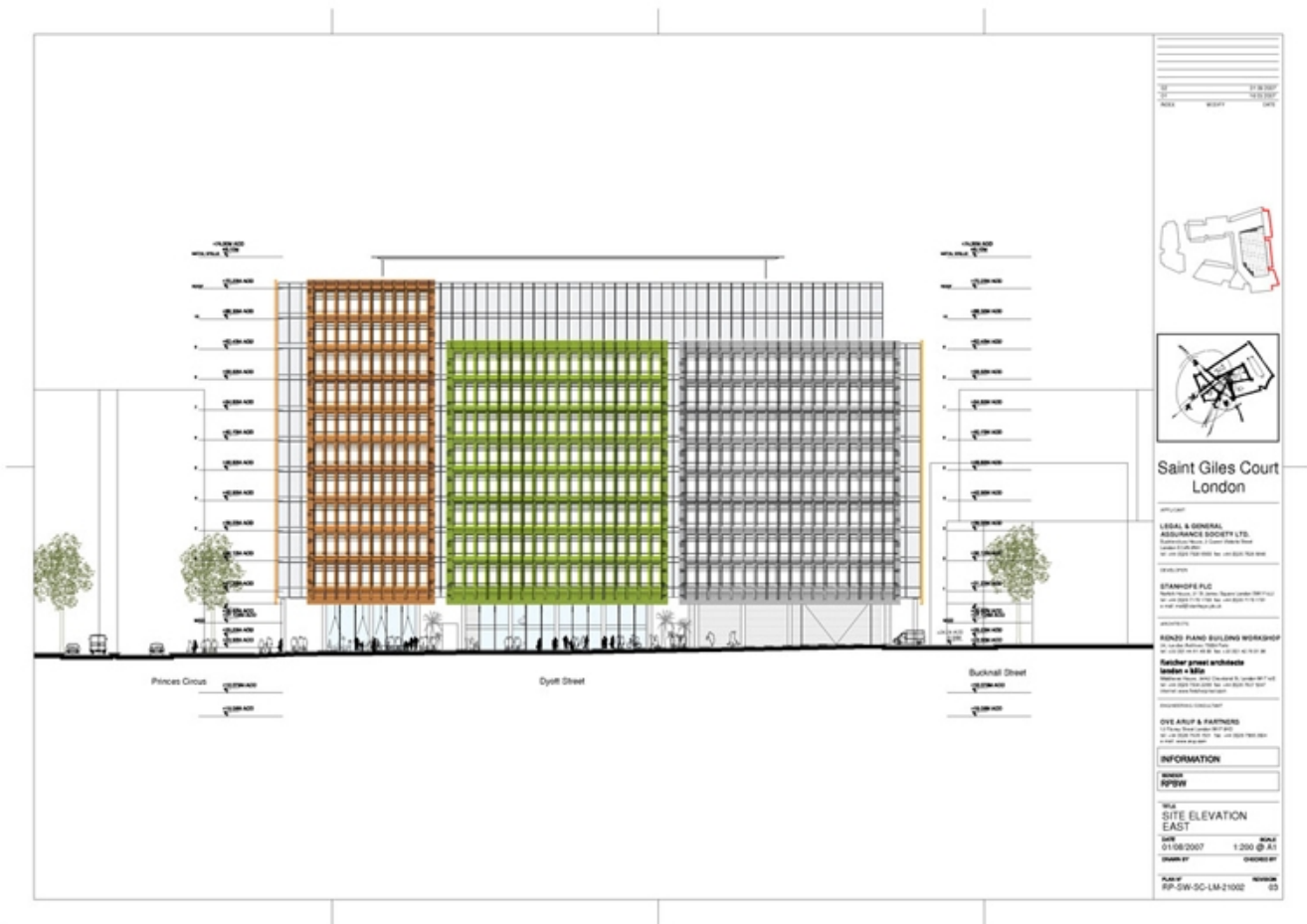

Titolo	Site Elevation East
Scala	1:200
Data	2007/09/01
Numero Disegno	RP-SW-SC-LM-21002
Codice disegno	SGI_DW_012
Autore	Renzo Piano Building Workshop
Copyright	Renzo Piano Building Workshop

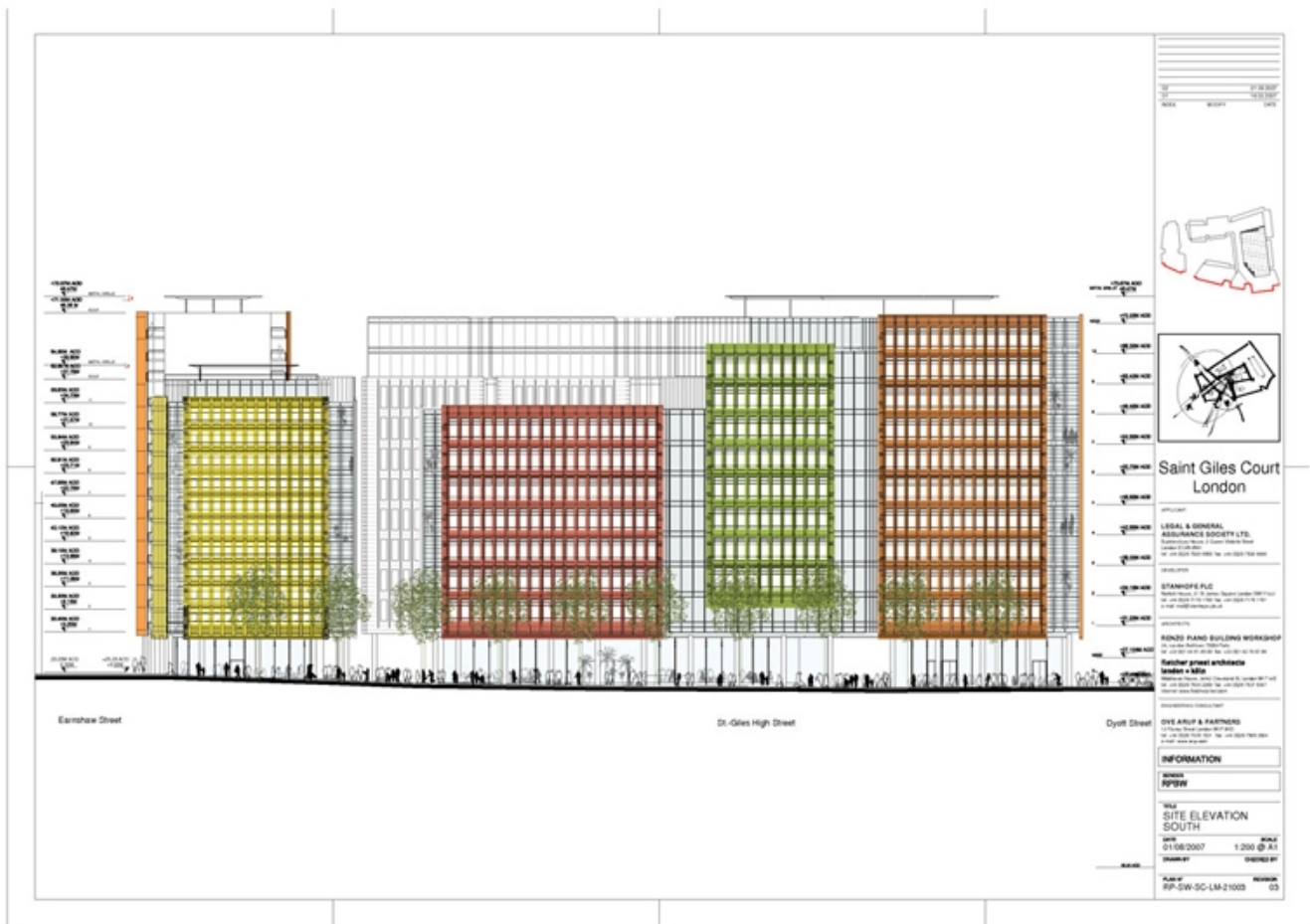

Titolo	Site Elevation South
Scala	1:200
Data	2007/09/01
Numero Disegno	RP-SW-SC-LM-21003
Codice disegno	SGI_DW_013
Autore	Renzo Piano Building Workshop
Copyright	Renzo Piano Building Workshop



Titolo	Site Elevation West
Scala	1:200
Data	2007/09/01
Numero Disegno	RP-SW-SC-LM-21004
Codice disegno	SGI_DW_014
Autore	Renzo Piano Building Workshop
Copyright	Renzo Piano Building Workshop



Titolo	Typical floor
Scala	1:200
Data	2006/01/01
Numero Disegno	-
Codice disegno	SGI_DW_435
Autore	Renzo Piano Building Workshop
Copyright	Renzo Piano Building Workshop



Titolo	Wall Types Ground level plan
Scala	1:200
Data	2007/12/03
Numero Disegno	FP-SW-SC-L00-20300
Codice disegno	SGI_DW_020
Autore	Renzo Piano Building Workshop
Copyright	Renzo Piano Building Workshop

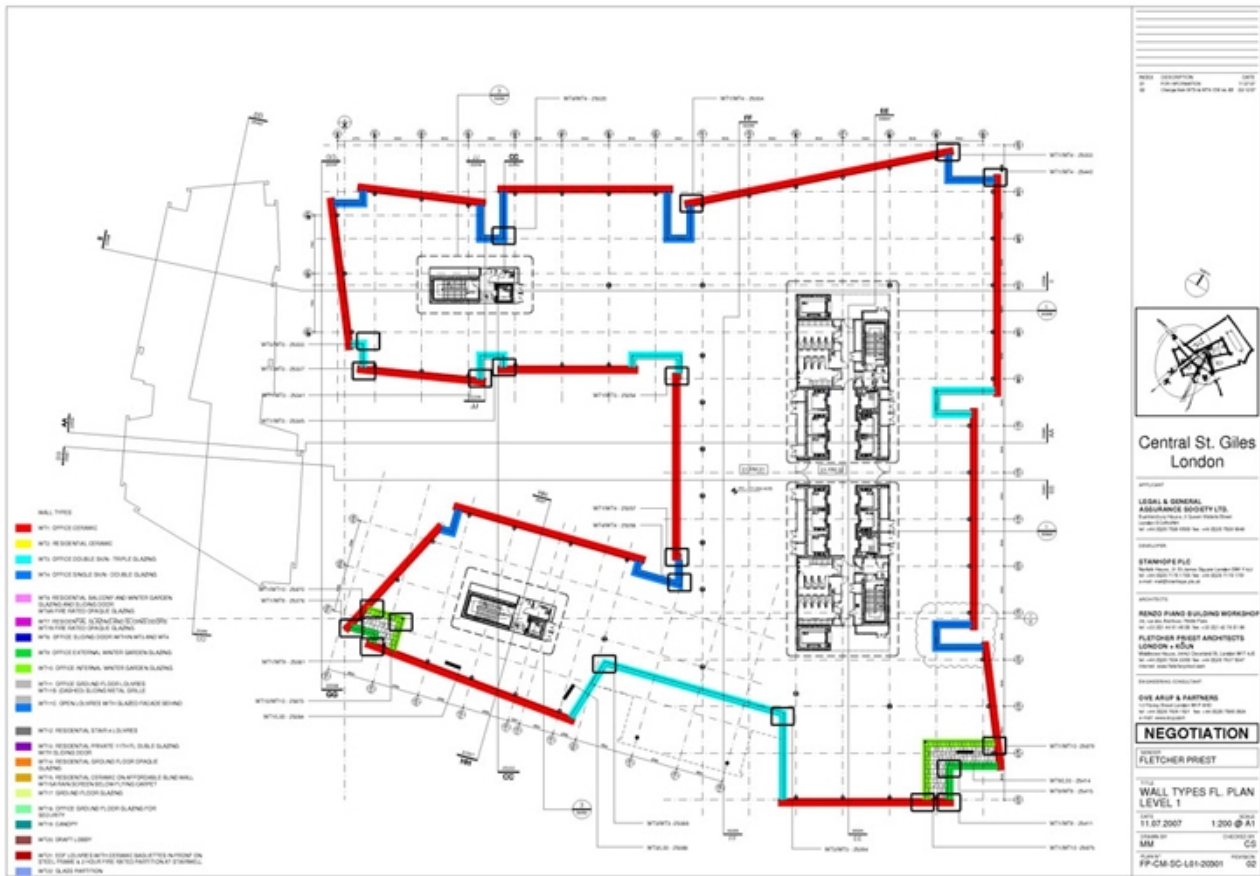

Titolo	Wall Types Fl. Plan level 1
Scala	1:200
Data	2007/12/03
Numero Disegno	FP-SW-SC-L00-20301
Codice disegno	SGI_DW_021
Autore	Renzo Piano Building Workshop
Copyright	Renzo Piano Building Workshop



Titolo	Wall Types Resi level 1/Typical
Scala	1:200
Data	2007/12/03
Numero Disegno	FP-SW-SC-L00-20310
Codice disegno	SGI_DW_021
Autore	Fletcher Priest Architects
Copyright	Renzo Piano Building Workshop

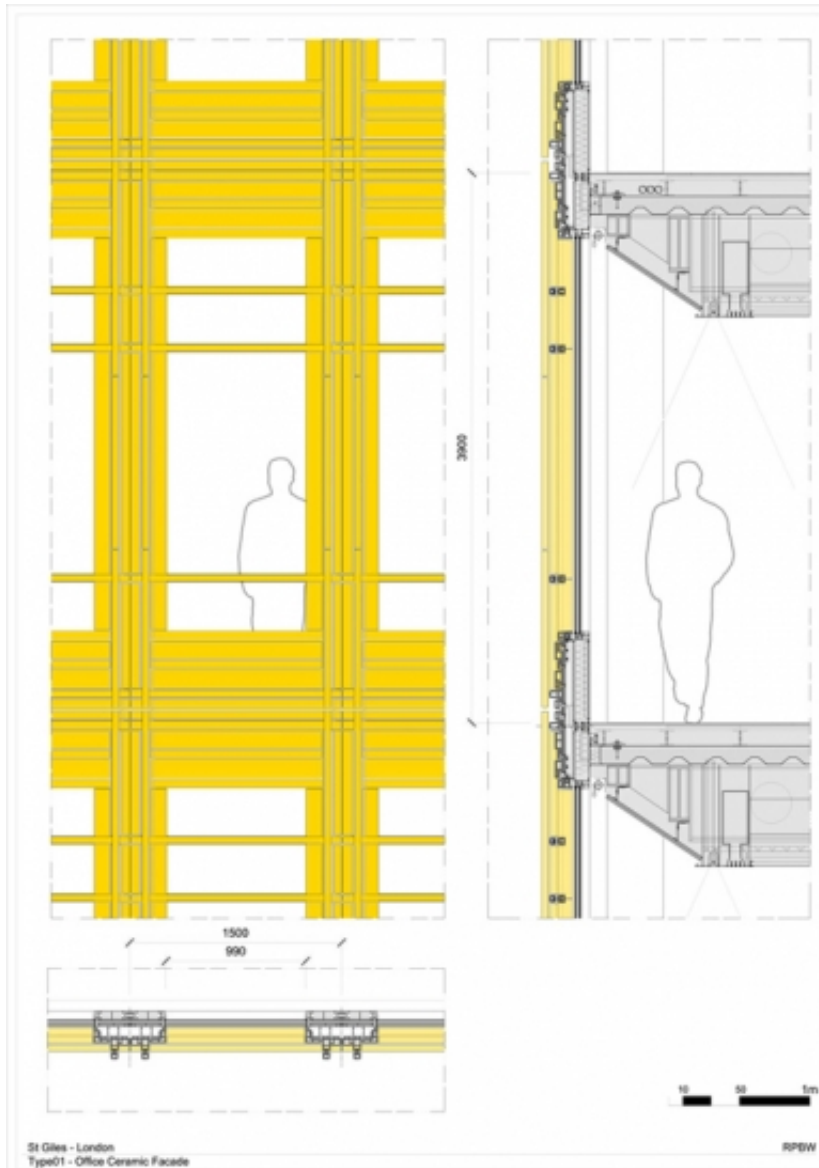

Titolo	Type01 - Office Ceramic Facade
Scala	-
Data	2009/07/03
Numero Disegno	FP-SW-SC-L00-20310
Codice disegno	SGI_DW_033
Autore	Renzo Piano Building Workshop

Copyright

Renzo Piano Building Workshop

TERRART® - Type 01

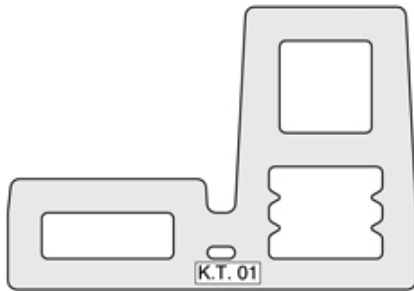

TEIL K.T.01

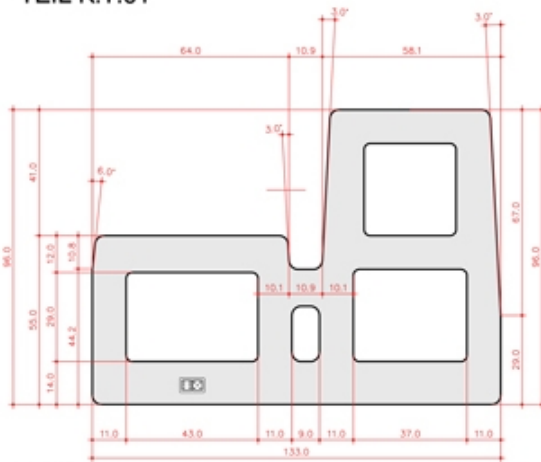

NEUTEIL 11

Alle Radien 3 mm

CSG Central St. Giles - Ceramic Facades - Neuteil 11 - Sc. 1/1 - RPBW April 2007

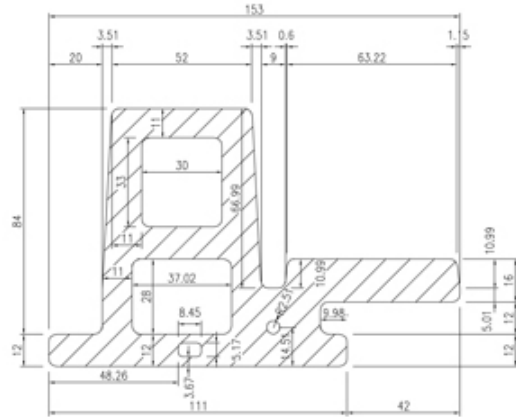

APPROVED BY:
PROJECT: CSG
NBK COLOUR: M 1.01-0
CLIENT:
DATE: 27.03.2007
SIGNATURE:

Dryhole position and size
by NBK

All Radius = (3mm)

B			
Revised :	Date :	Modification :	Checked :
 Reeser Strasse 235 46446 Emmerich Tel.: +49 2822 8111 - 0 Fax: +49 2822 8111 - 20 http://www.nbk.de info@nbk-keramik.de			
Drawn :	Date :	Size :	Checked :
Stroescu	27.03.2007	A4	
Title :			Drawing No.:
TerrArt Type 01			01
CSG			Rev.:
Project :			Project No.:
			Scale : 1 : 3

Titolo TerrArt Type 01 CSG

Scala NTS

Data 2007/03/27

Numero Disegno -

Codice disegno SGI_DW_444

Autore NBK Keramik

Copyright NBK Keramik

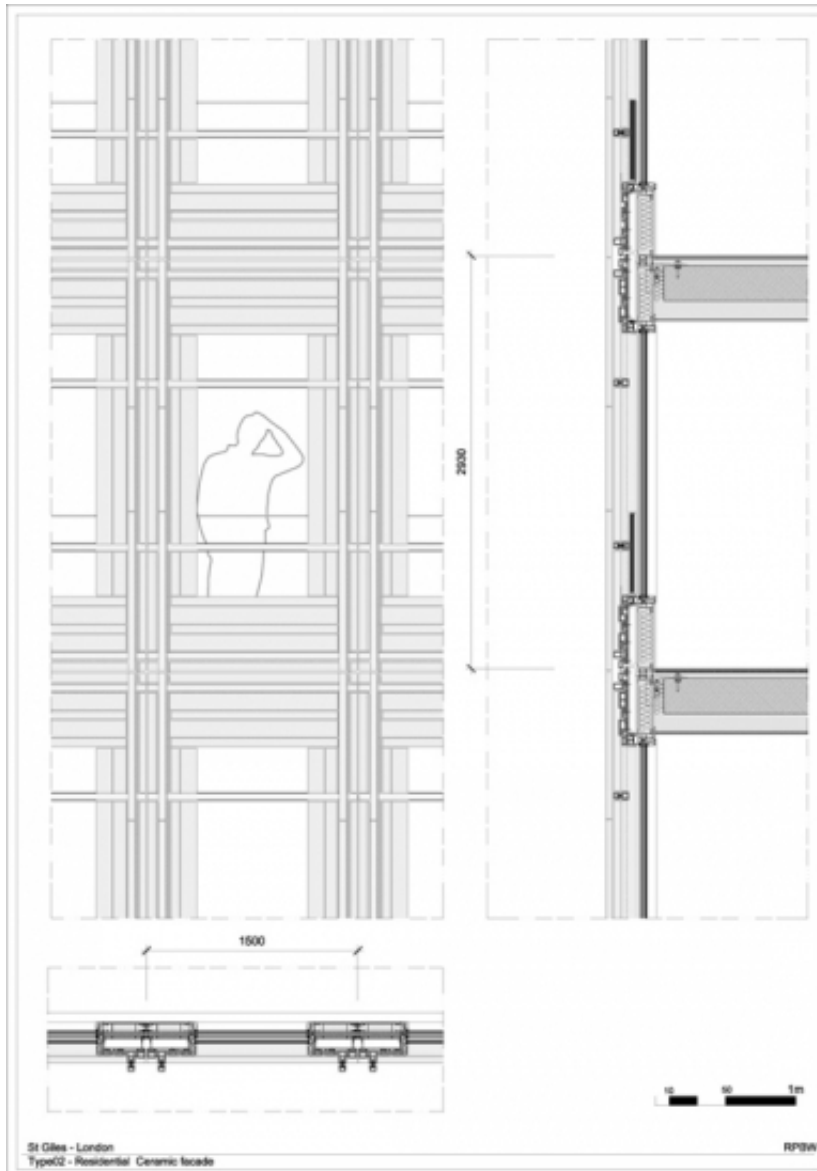

Titolo	Type02 - Residential Ceramic facade
Scala	1:10
Data	2009/07/03
Numero Disegno	-
Codice disegno	SGI_DW_051
Autore	Renzo Piano Building Workshop

Copyright

Renzo Piano Building Workshop

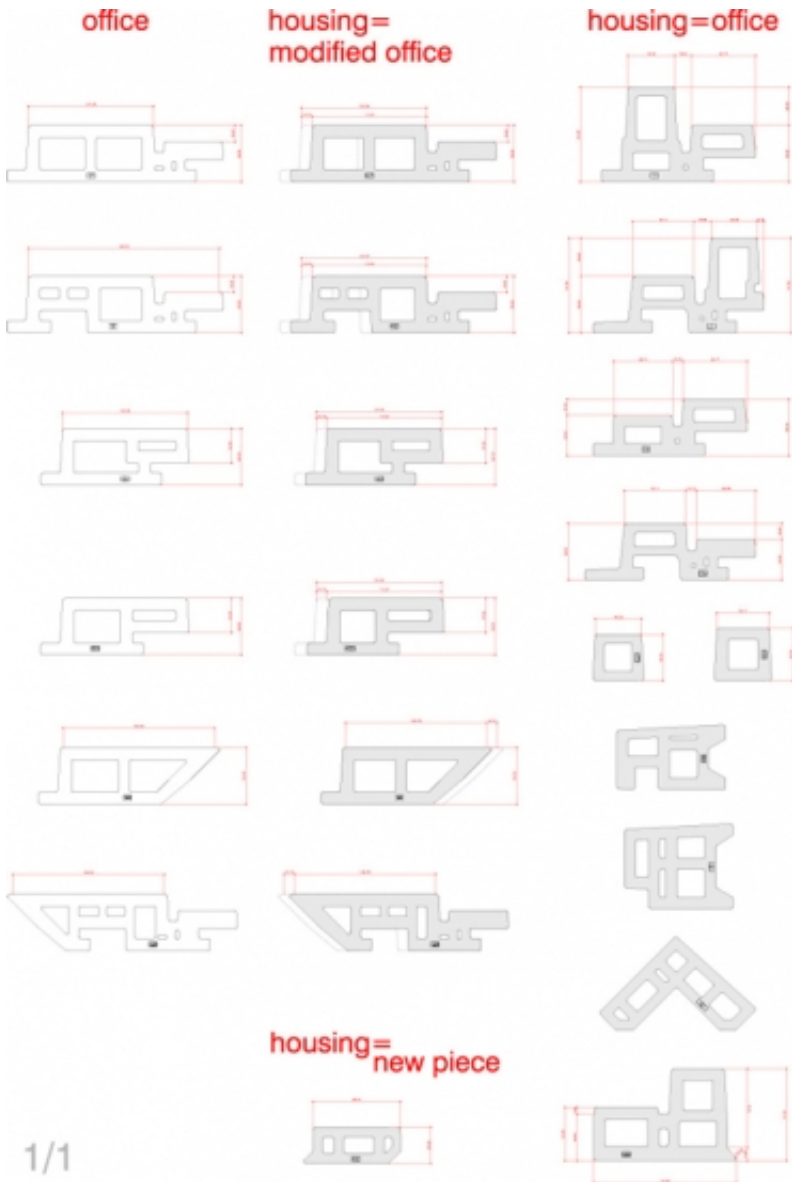

Titolo	Type02 - Housing pieces
Scala	1:11
Data	2007/11/01
Numero Disegno	-
Codice disegno	SGI_DW_052
Autore	Renzo Piano Building Workshop

Copyright

Renzo Piano Building Workshop

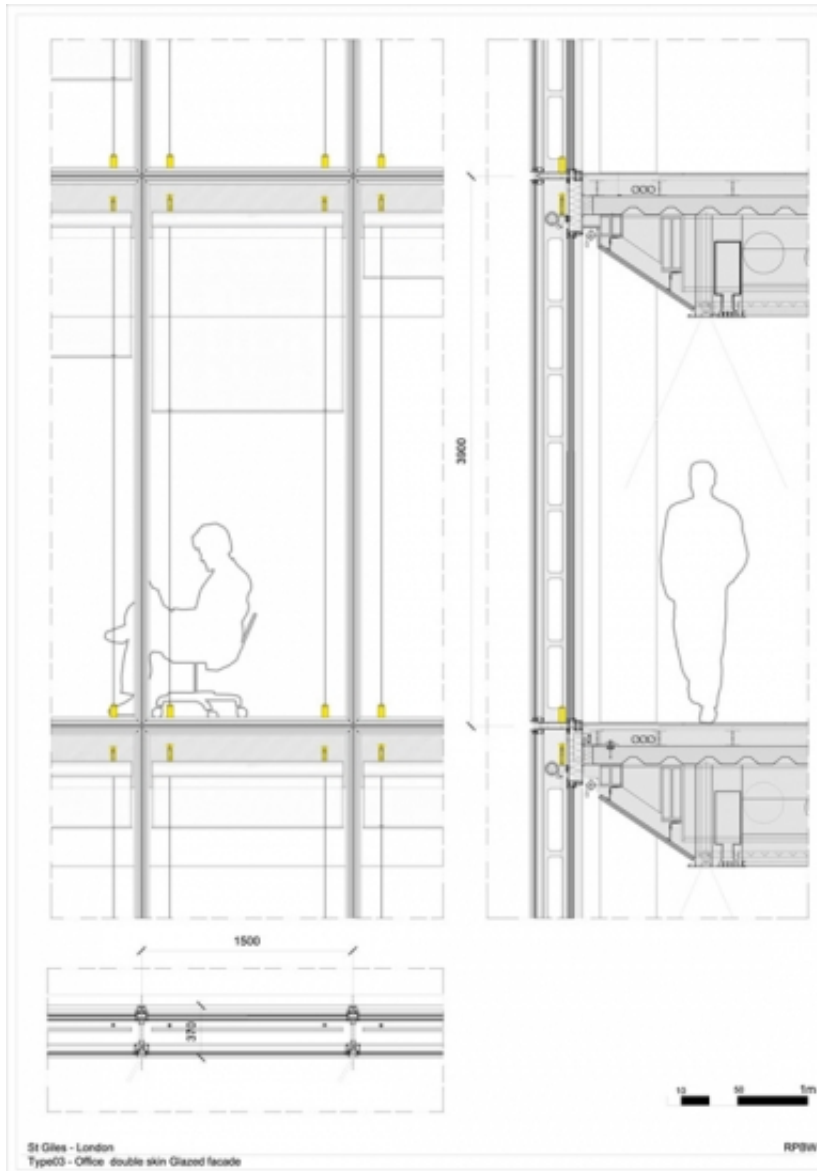

Titolo	Type03 - Office double skin Glazed facade
Scala	1:10
Data	2009/07/03
Numero Disegno	-
Codice disegno	SGI_DW_064
Autore	Renzo Piano Building Workshop

Copyright

Renzo Piano Building Workshop

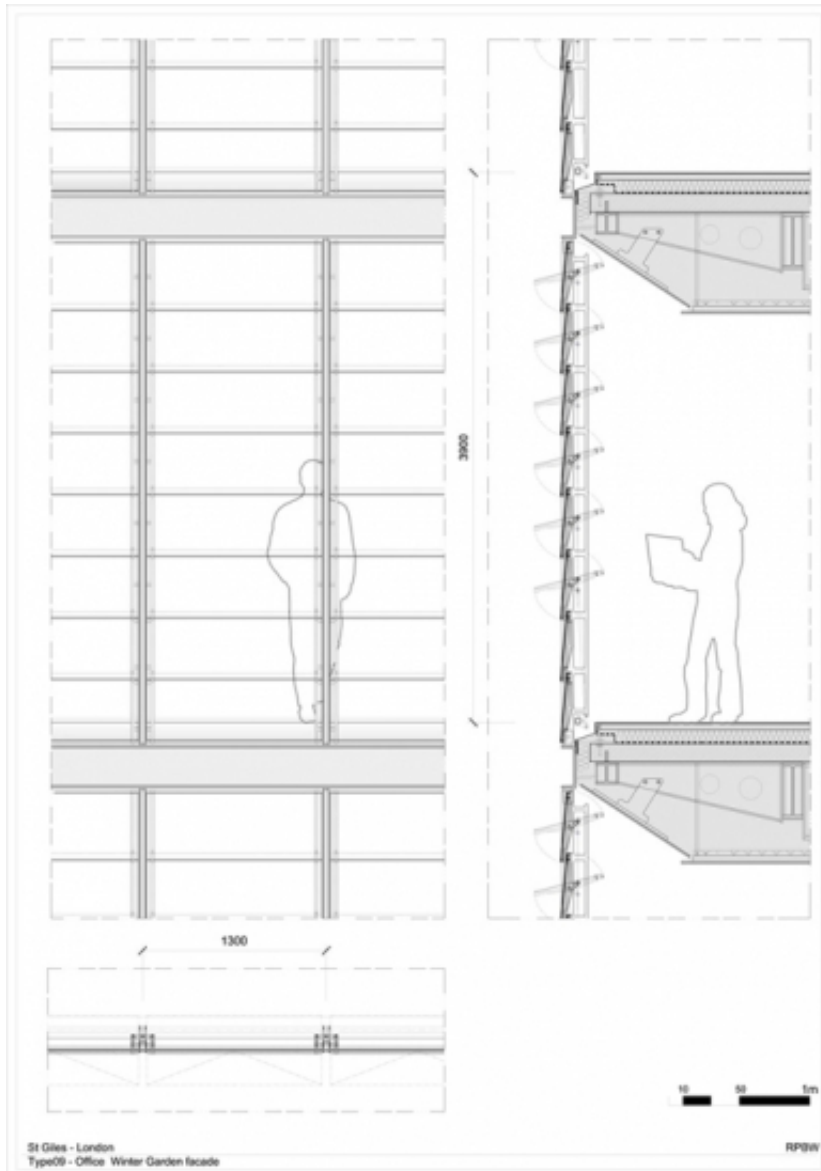

Titolo	Type09 - Office Winter Garden facade
Scala	1:10
Data	2009/07/03
Numero Disegno	-
Codice disegno	SGL_DW_094
Autore	Renzo Piano Building Workshop

Copyright

Renzo Piano Building Workshop

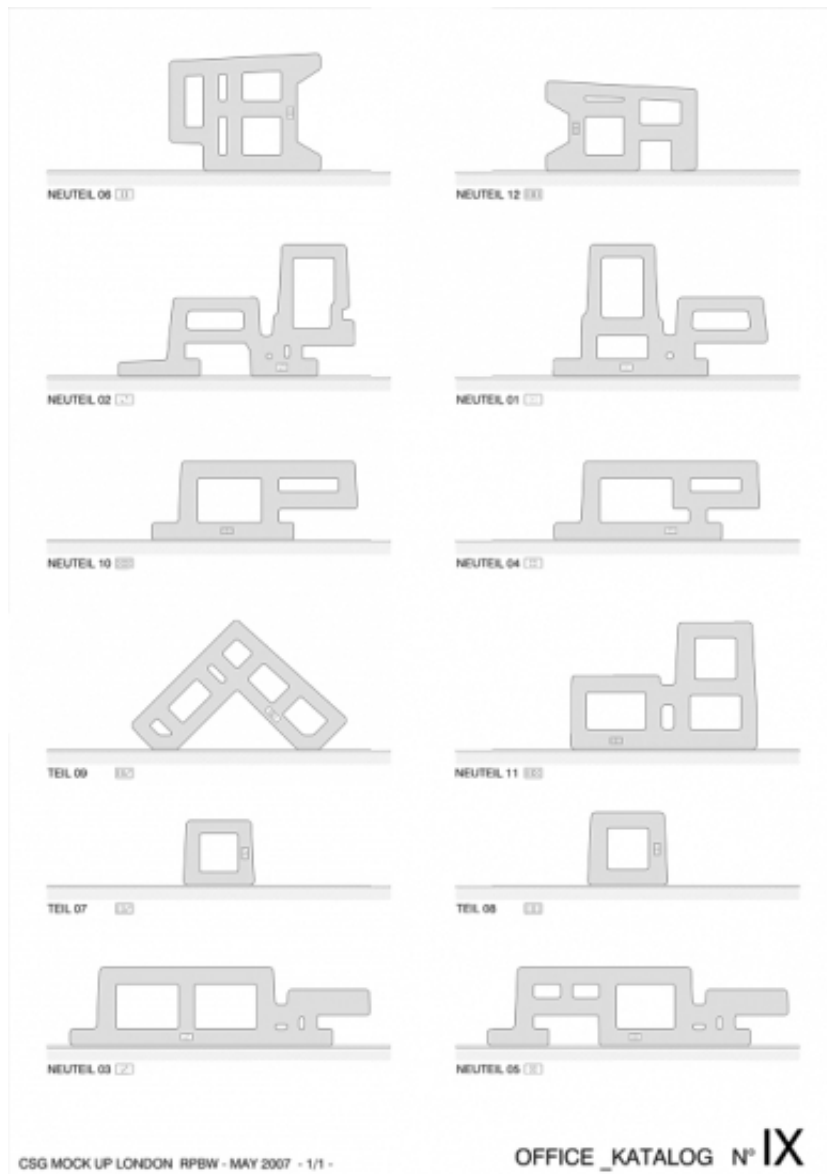

Titolo	Ceramic facades - Mock up London
Scala	1:1
Data	2007/05/01
Numero Disegno	-
Codice disegno	SGI_DW_446
Autore	Renzo Piano Building Workshop

Copyright

Renzo Piano Building Workshop

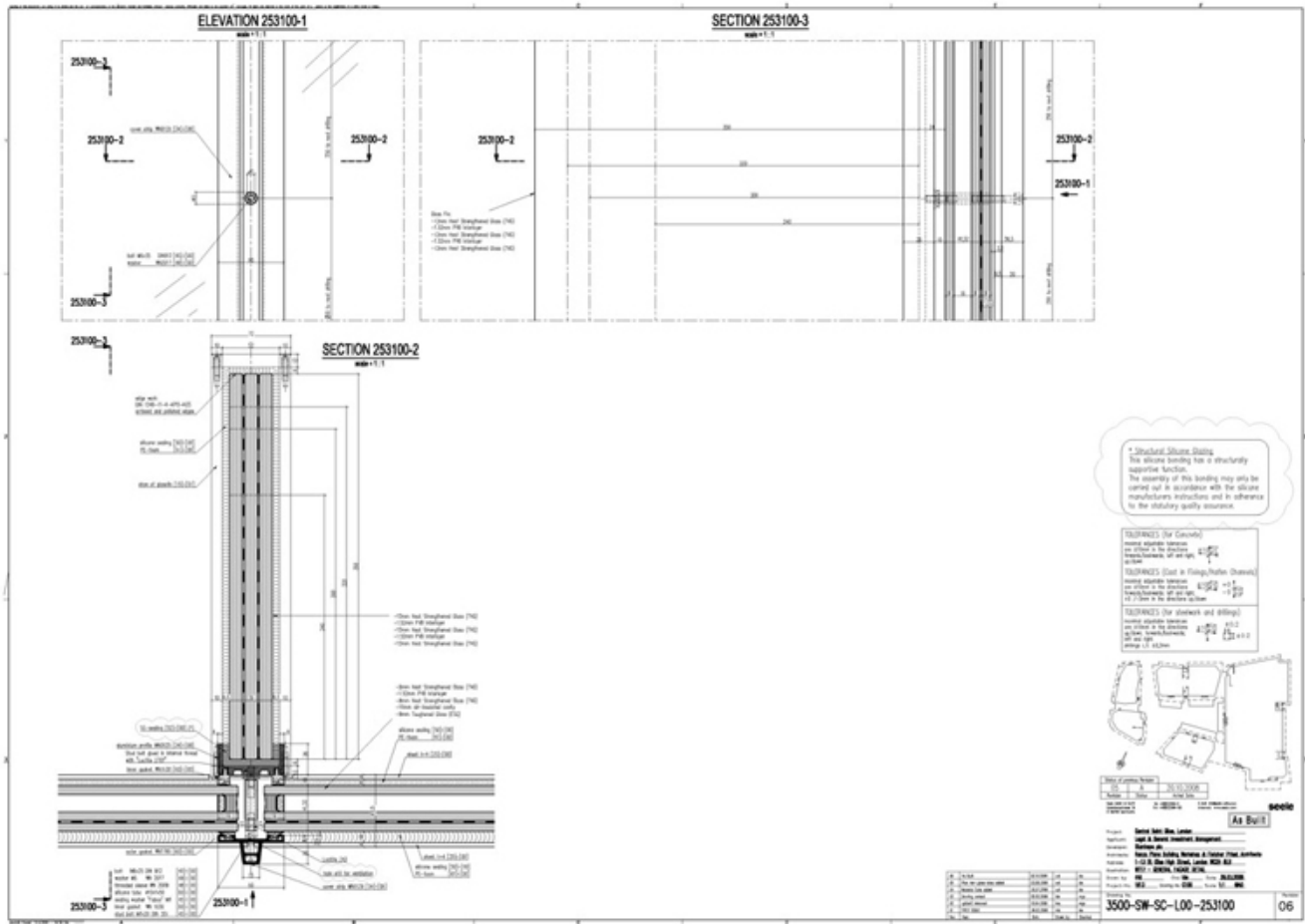

Titolo WT17 - General facade detail

Scala 1:1

Data 2009/10/02

Numero Disegno 3500-SW-SC-L00-253100

Codice disegno SGI_DW_169

Autore Seele GmbH & Co.

Copyright Seele GmbH & Co.

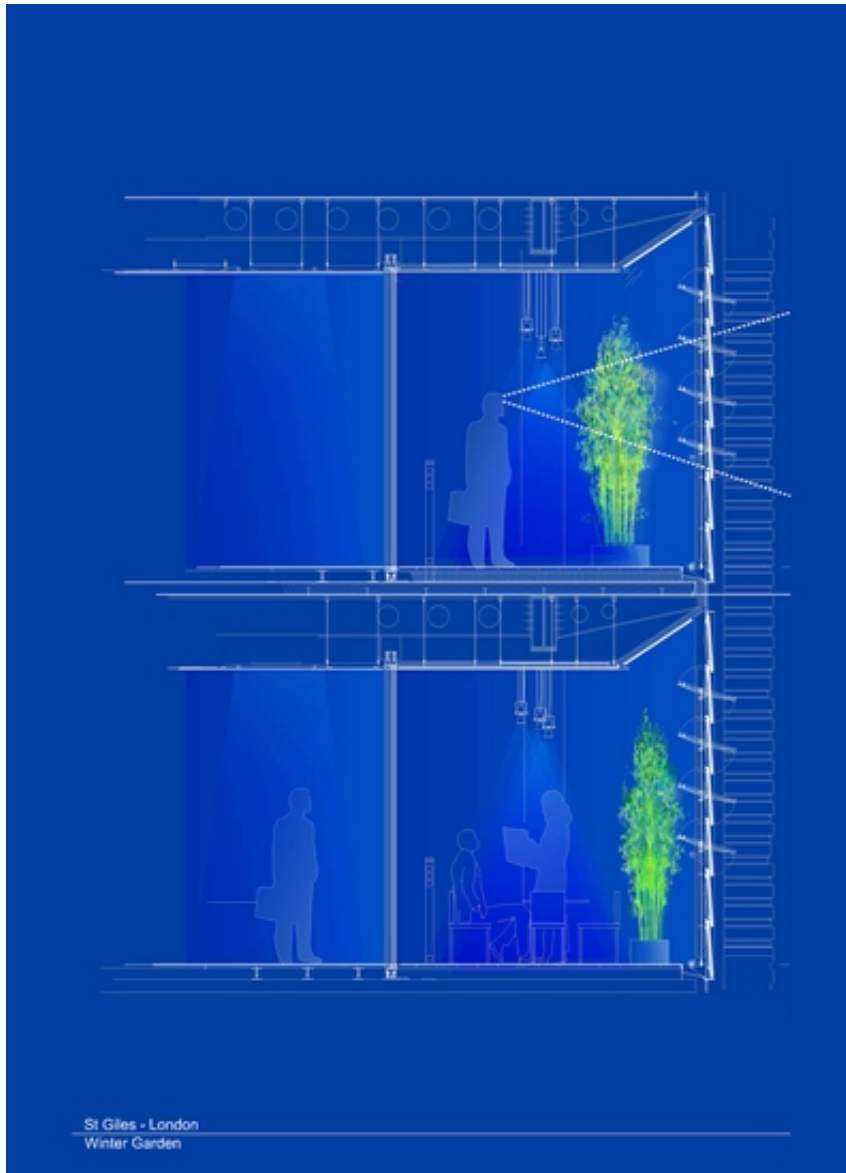

Titolo	Winter garden
Scala	NTS
Data	2010/05/25
Numero Disegno	-
Codice disegno	SGI_DW_447
Autore	Renzo Piano Building Workshop

Copyright

Renzo Piano Building Workshop



Titolo	Reference Construction Office Lobby Elevation 1
Scala	1:20
Data	2008/01/24
Numero Disegno	-
Codice disegno	SGI_DW_413
Autore	Renzo Piano Building Workshop
Copyright	Renzo Piano Building Workshop

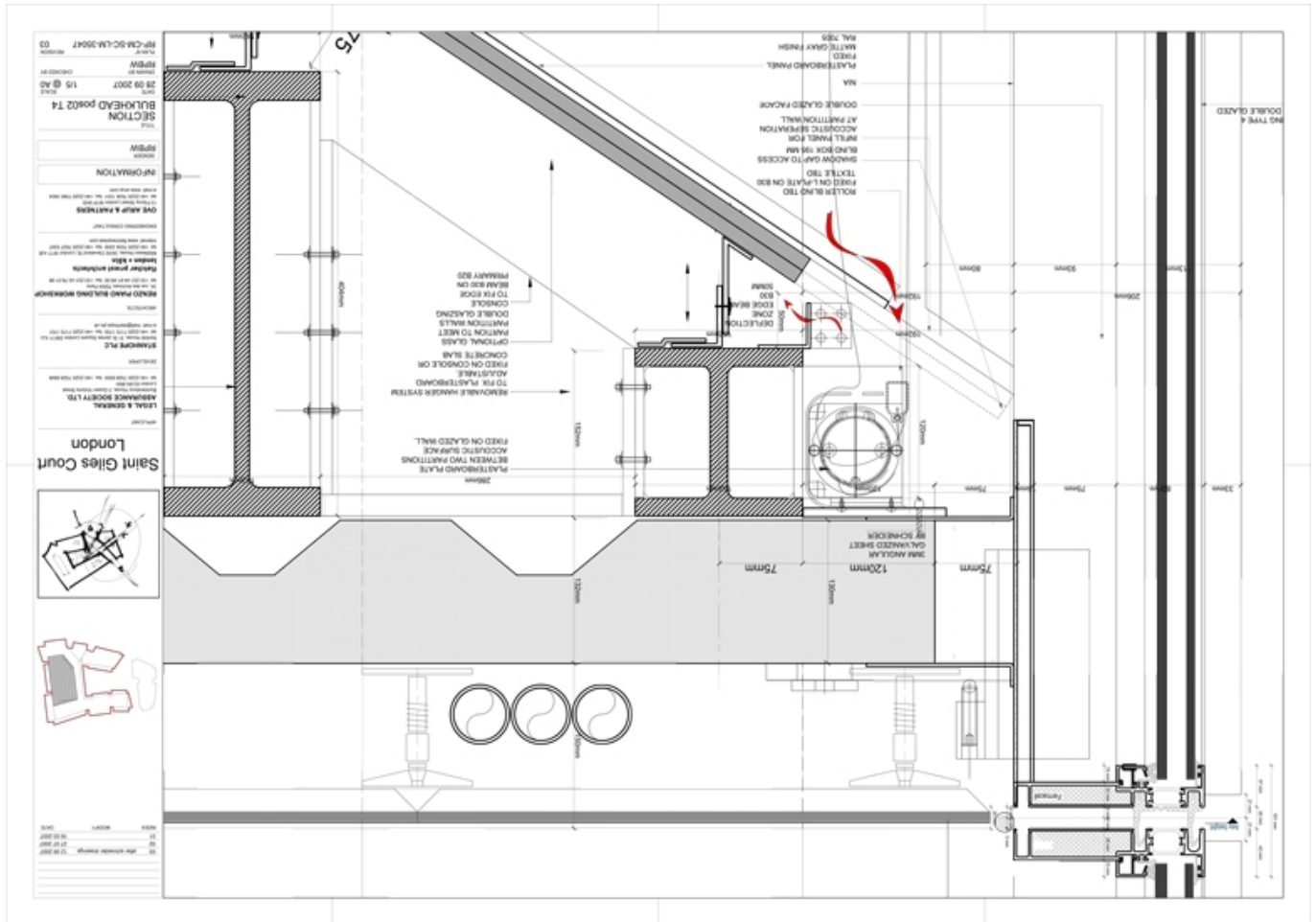

Titolo	Section bulkhead pos02/T4
Scala	1:10
Data	2007/09/28
Numero Disegno	RP-CM-SC-LM-35047
Codice disegno	SGI_DW_439
Autore	Renzo Piano Building Workshop
Copyright	Renzo Piano Building Workshop

Modelli

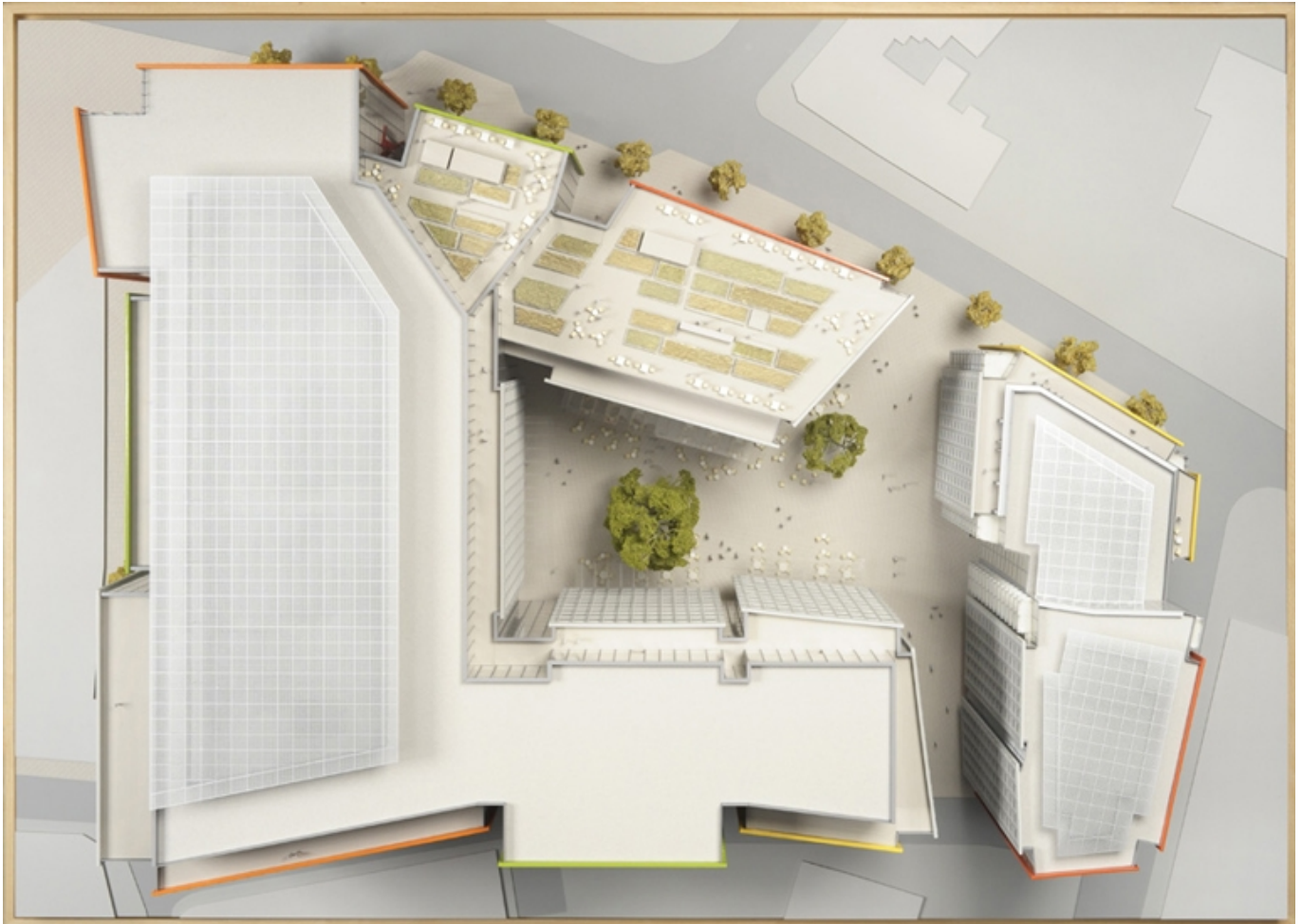

Titolo	General Building Presentation Model
Data	2008/02/29
Codice Modello	SGI_MD_046
Scala	1:100
Autore Modello	Goudin, Michel



Titolo	General Building Presentation Model
Data	2008/02/29
Codice Modello	SGI_MD_046
Scala	1:100
Autore Modello	Goudin, Michel



Titolo	General Building Presentation Model
Data	2008/02/29
Codice Modello	SGI_MD_046
Scala	1:100
Autore Modello	Goudin, Michel



Titolo	South Elevation Bas Relief
Data	2006/11
Codice Modello	SGI_MD_041
Scala	1:100
Autore Modello	RPBW



Titolo	Façade Detailed Presentation Model
Data	2006/03/01
Codice Modello	SGI_MD_035
Scala	1:33
Autore Modello	RPBW



Titolo	Ceramic Profiles Samples
Data	2007/06/01
Codice Modello	SGI_MD_037
Scala	1:1
Autore Modello	RPBW

