

Kimbell Art Museum Expansion



Dati Progetto

Progettazione	2007-2010
Costruzione	2010-2013
Area del sito	42.685 m2 (compreso il museo di Kahn)
Superficie costruita	7.600 m2
Altezza	7 m
Piani	1+1 interrato
Auditorium	298 posti

Credits

Cliente	Kimbell Art Foundation
Architetto	Renzo Piano Building Workshop, in collaborazione con Kendall/Heaton Associates, Inc. (Houston)
Consulenti	Guy Nordenson & Associates with Brockett, Davis, Drake Inc (structure); Arup with Summit Consultants (services) Arup (lighting); Front (façade consultant); Pond & Company (landscape), Harvey Marshall Berling Associates Inc. (acoustical/audiovisual), Dottor Group (concrete consultant), Stuart-Lynn Company (cost consultant)

Immagini



Soggetto

Foto aerea del sito. L'ampliamento è posto a 60 metri dall'edificio di Louis Kahn

Data

Codice Immagine

Kim_145

Autore

Copyright

Google



Soggetto

Foto aerea del sito

Data

Codice Immagine

Kim_143

Autore

Copyright

Google



Soggetto Vista aerea del cantiere

Data 2010-10-29

Codice Immagine Kim__189

Autore

Copyright Smith Aerial Photo



Soggetto	Scavi
Data	2012-01-01
Codice Immagine	Kim__210
Autore	Teke, Onur
Copyright	RPBW - Renzo Piano Building Workshop Architects



Soggetto	Assemblaggio della cassaforma
Data	2012-01-01
Codice Immagine	Kim__225
Autore	Teke, Onur
Copyright	RPBW - Renzo Piano Building Workshop Architects



Soggetto	Cassaforma in cantiere
Data	2012-01-01
Codice Immagine	Kim__245
Autore	Teke, Onur
Copyright	RPBW - Renzo Piano Building Workshop Architects



Soggetto	Cassaforma in cantiere
Data	2012-01-01
Codice Immagine	Kim__245
Autore	Teke, Onur
Copyright	RPBW - Renzo Piano Building Workshop Architects



Soggetto

Vista aerea del sito

Data

2013-10-01

Codice Immagine

Kim_601

Autore

Copyright

Aerial Photography Inc.



Soggetto

Vista esterna. La copertura è costituita da un sistema di lamelle in alluminio orientabili e celle fotovoltaiche

Data

2015-05-01

Codice Immagine

Kim__986

Autore

Teke, Onur

Copyright

RPBW - Renzo Piano Building Workshop Architects



Soggetto	Vista esterna del museo di Kahn e del nuovo Padiglione del museo Kimbell
Data	2013-11-19
Codice Immagine	Kim__720
Autore	Ishida, Shunji
Copyright	RPBW - Renzo Piano Building Workshop Architects



Soggetto	Vista esterna dal giardino
Data	2013-11-27
Codice Immagine	Kim__964
Autore	Lehoux, Nic
Copyright	RPBW - Renzo Piano Building Workshop Architects



Soggetto	Vista esterna notturna dal giardino
Data	2013-11-27
Codice Immagine	Kim__971
Autore	Lehoux, Nic
Copyright	RPBW - Renzo Piano Building Workshop Architects



Soggetto	Vista esterna notturna
Data	2013-11-27
Codice Immagine	Kim_972
Autore	Lehoux, Nic
Copyright	RPBW - Renzo Piano Building Workshop Architects



Soggetto	Dettaglio di facciata notturno
Data	2013-11-27
Codice Immagine	Kim_976
Autore	Lehoux, Nic
Copyright	RPBW - Renzo Piano Building Workshop Architects



Soggetto	Vista del vetro di copertura
Data	2013-11-27
Codice Immagine	Kim_948
Autore	Lehoux, Nic
Copyright	RPBW - Renzo Piano Building Workshop Architects



Soggetto	Colonnato esterno
Data	2013-11-27
Codice Immagine	Kim_940
Autore	Lehoux, Nic
Copyright	RPBW - Renzo Piano Building Workshop Architects



Soggetto

Dettaglio del colonnato esterno

Data

Codice Immagine

Kim_1004

Autore

Teke, Onur

Copyright

RPBW - Renzo Piano Building Workshop Architects



Soggetto	Dettaglio della copertura. Il sistema di copertura integra le travi lamellari a un sistema di lamelle in alluminio, orientate a nord, e pannelli solari orientati sopra vetro sinterizzato e velari tesi
Data	2013-05-01
Codice Immagine	Kim_633
Autore	Teke, Onur
Copyright	RPBW - Renzo Piano Building Workshop Architects



Soggetto	Dettaglio della copertura
Data	
Codice Immagine	Kim_1002
Autore	Teke, Onur
Copyright	RPBW - Renzo Piano Building Workshop Architects



Soggetto	Dettaglio del rivestimento di facciata
Data	
Codice Immagine	Kim_1001
Autore	Teke, Onur
Copyright	RPBW - Renzo Piano Building Workshop Architects



Soggetto

Vista interna della galleria

Data

2013-11-27

Codice Immagine

Kim_950

Autore

Lehoux, Nic

Copyright

RPBW - Renzo Piano Building Workshop Architects



Soggetto

Vista interna della galleria

Data

2013-11-27

Codice Immagine

Kim__952

Autore

Lehoux, Nic

Copyright

RPBW - Renzo Piano Building Workshop Architects

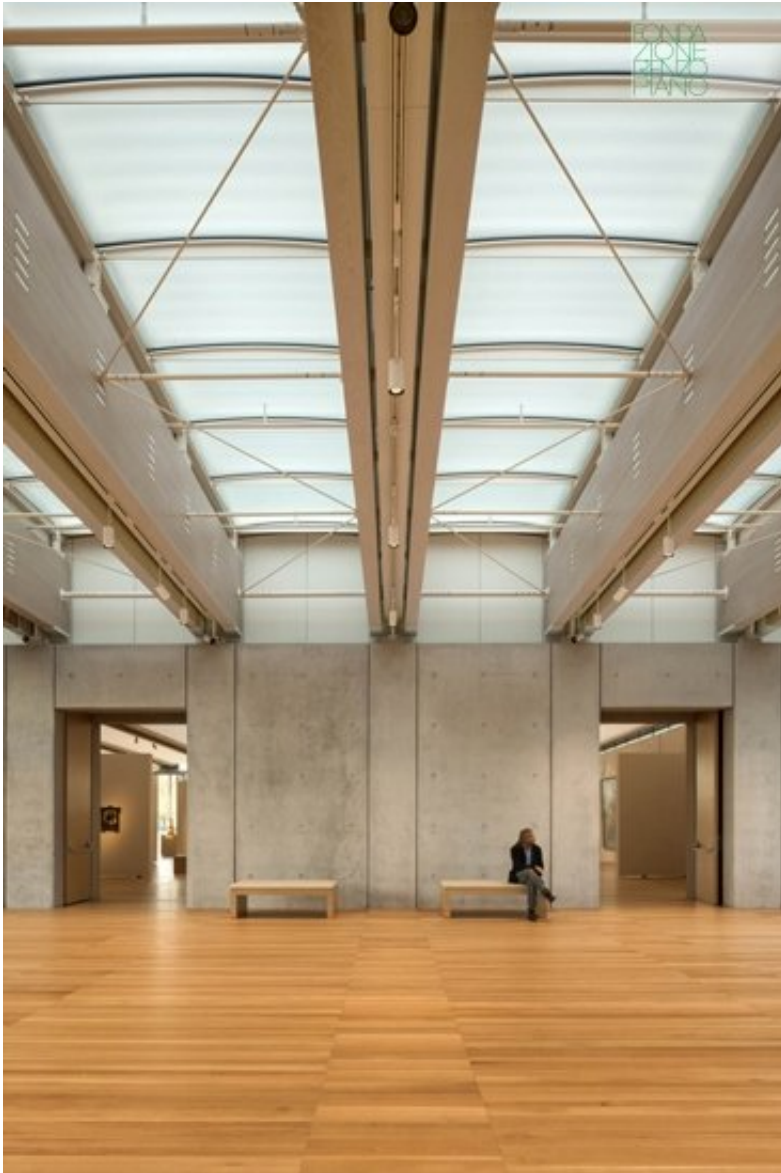

Soggetto	Vista dello spazio interno della galleria e copertura
Data	2013-11-27
Codice Immagine	Kim_953
Autore	Lehoux, Nic
Copyright	RPBW - Renzo Piano Building Workshop Architects

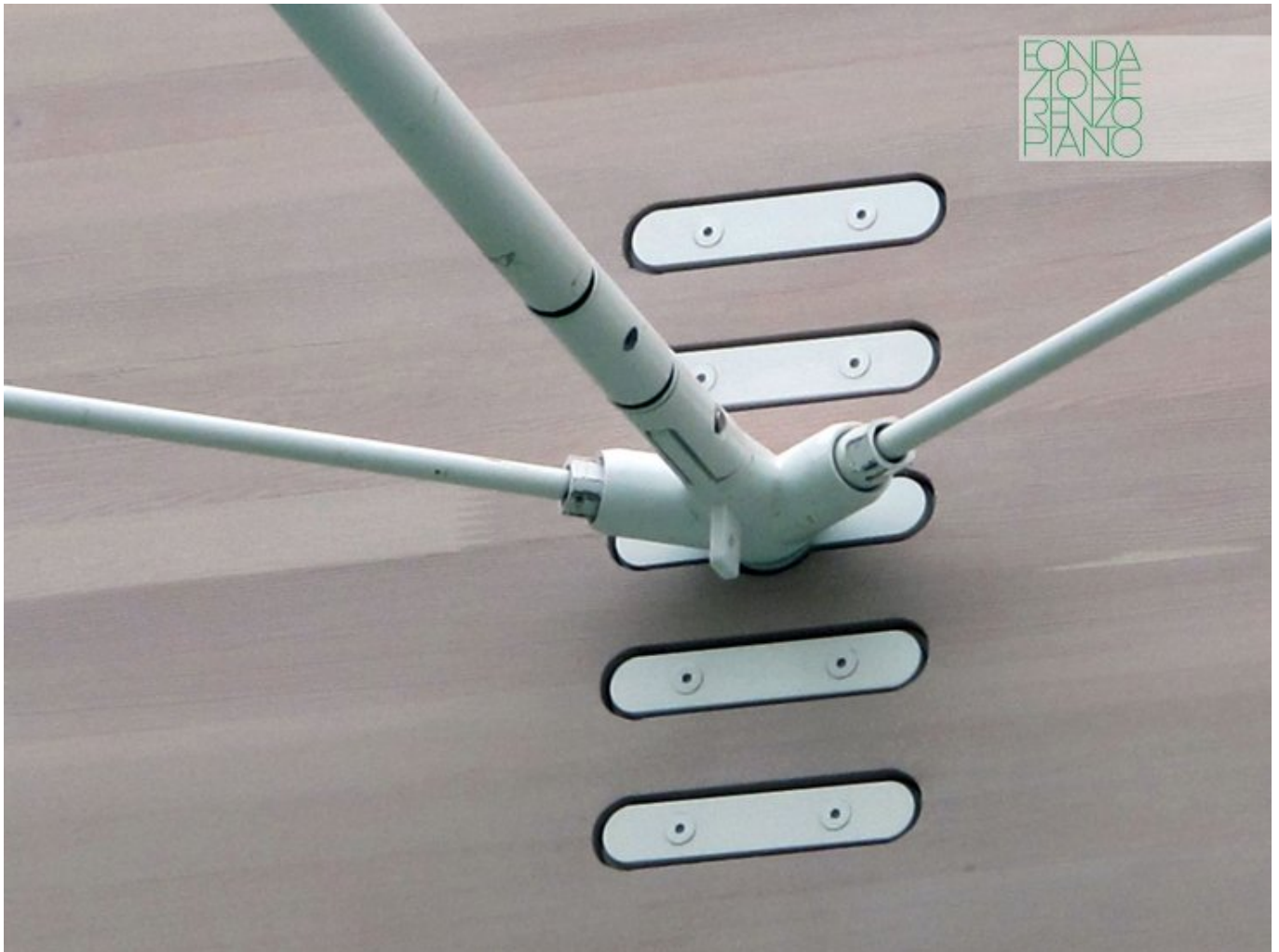

Soggetto	Joint structure detail
Data	
Codice Immagine	Kim_1003
Autore	Teke, Onur
Copyright	RPBW - Renzo Piano Building Workshop Architects



Soggetto

Vista interna su uno spazio espositivo. Gli spazi interni, in gran parte continui e modificabili, sono definiti da 29 coppie di travi lamellari lunghe 30 m, in pino Douglas

Data

2013-11-27

Codice Immagine

Kim__960

Autore

Lehoux, Nic

Copyright

RPBW - Renzo Piano Building Workshop Architects



Soggetto

Vista interna. Atrio

Data

2013-11-19

Codice Immagine

Kim_854

Autore

Lehoux, Nic

Copyright

RPBW - Renzo Piano Building Workshop Architects



Soggetto

Galleria, particolare di una statua

Data

2013-11-27

Codice Immagine

Kim__961

Autore

Lehoux, Nic

Copyright

RPBW - Renzo Piano Building Workshop Architects



Soggetto

Vista interna. Galleria con visitatori

Data

2013-11-27

Codice Immagine

Kim_908

Autore

Lehoux, Nic

Copyright

RPBW - Renzo Piano Building Workshop Architects



Soggetto	Vista interna. Galleria e scala interna
Data	2013-11-27
Codice Immagine	Kim__910
Autore	Lehoux, Nic
Copyright	RPBW - Renzo Piano Building Workshop Architects



Soggetto	Galleria, dettaglio di una statua
Data	2015-05-01
Codice Immagine	Kim_988
Autore	Teke, Onur
Copyright	RPBW - Renzo Piano Building Workshop Architects



Soggetto	Vista interna sulla galleria
Data	2015-05-01
Codice Immagine	Kim_989
Autore	Teke, Onur
Copyright	RPBW - Renzo Piano Building Workshop Architects



Soggetto	Spazio espositivo
Data	2013-12-03
Codice Immagine	Kim__983
Autore	Denancé, Michel
Copyright	Denancé, Michel



Soggetto	Dettaglio dell'esposizione
Data	2013-12-03
Codice Immagine	Kim_984
Autore	Denancé, Michel
Copyright	Denancé, Michel



Soggetto

Vista interna su galleria e scale in legno

Data

2013-11-19

Codice Immagine

Kim_864

Autore

Lehoux, Nic

Copyright

RPBW - Renzo Piano Building Workshop Architects



Soggetto	Dettaglio della scala interna in legno
Data	2013-11-19
Codice Immagine	Kim_867
Autore	Lehoux, Nic
Copyright	RPBW - Renzo Piano Building Workshop Architects



Soggetto

Vista del palcoscenico dell'auditorium

Data

2013-11-19

Codice Immagine

Kim__870

Autore

Lehoux, Nic

Copyright

RPBW - Renzo Piano Building Workshop Architects



Soggetto	Auditorium di 298 posti, collocato al livello inferiore, con una parete interamente vetrata
Data	2013-11-19
Codice Immagine	Kim__871
Autore	Lehoux, Nic
Copyright	RPBW - Renzo Piano Building Workshop Architects

Disegni



Titolo	-
Scala	-
Dimensione	A3
Data	2008/03/03
Numero Disegno	-

Codice disegno	Kim-rp_216
----------------	------------

Autore	Renzo Piano
--------	-------------

Copyright	Renzo Piano
-----------	-------------

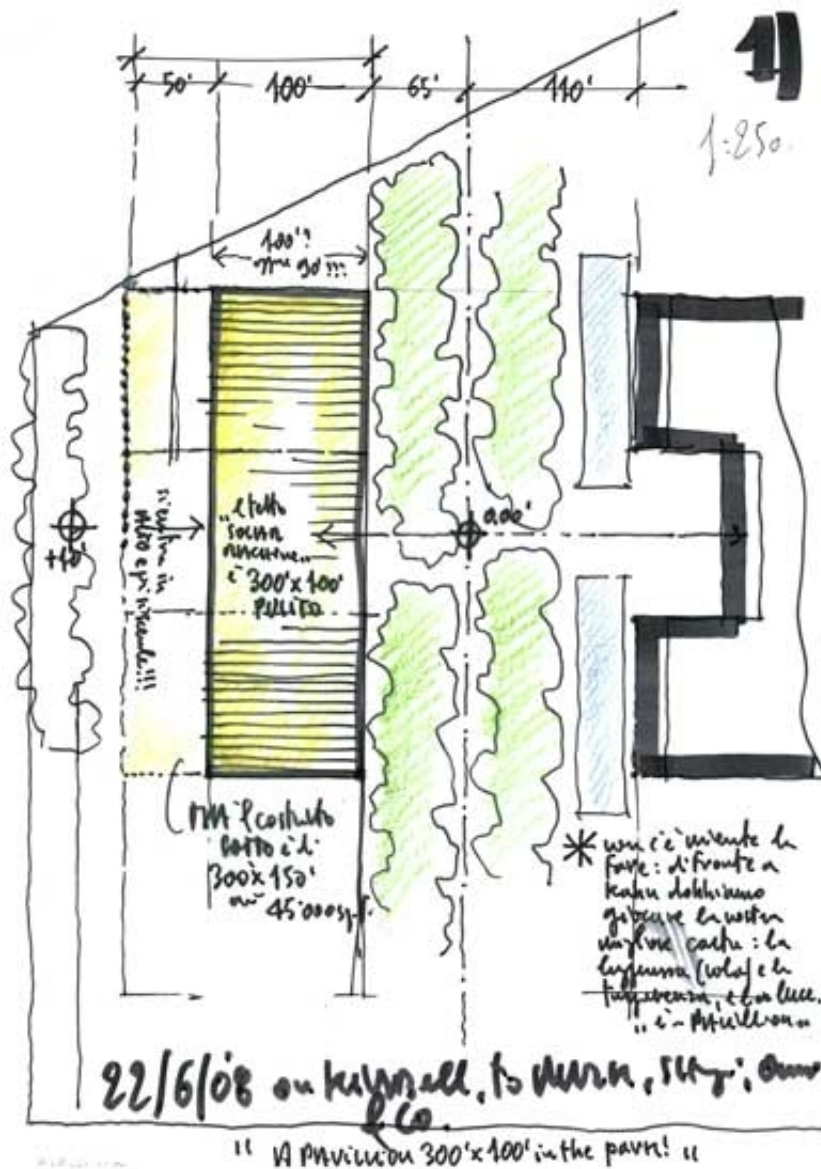

Titolo	-
Scala	-
Dimensione	A4
Data	2008/06/22
Numero Disegno	-
Codice disegno	Kim-rp_383

Autore	Renzo Piano
--------	-------------

Copyright	Renzo Piano
-----------	-------------

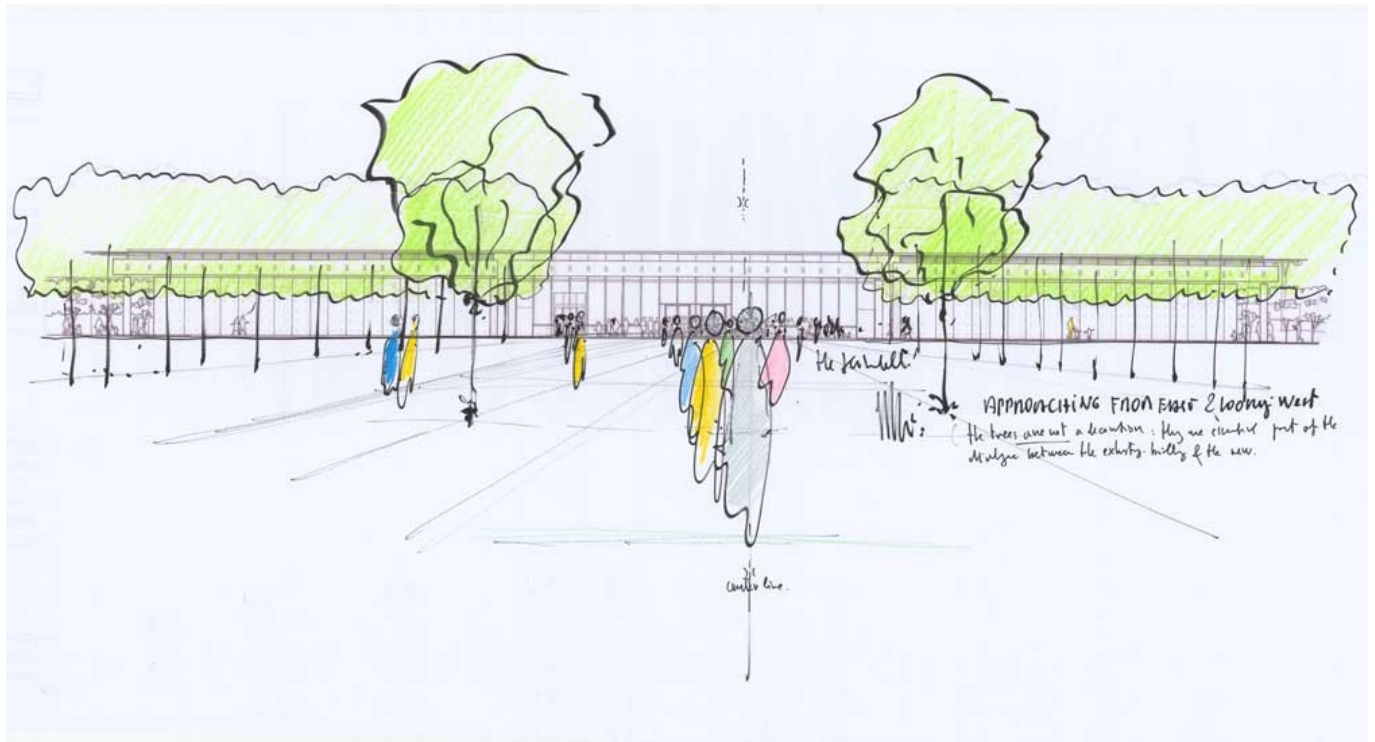

Titolo	Approaching from East (Avvicinandosi da Est)
Scala	-
Dimensione	91.4x47.5 cm
Data	2011/01/01
Numero Disegno	-
Codice disegno	Kim-rp_882
Autore	Renzo Piano
Copyright	Renzo Piano

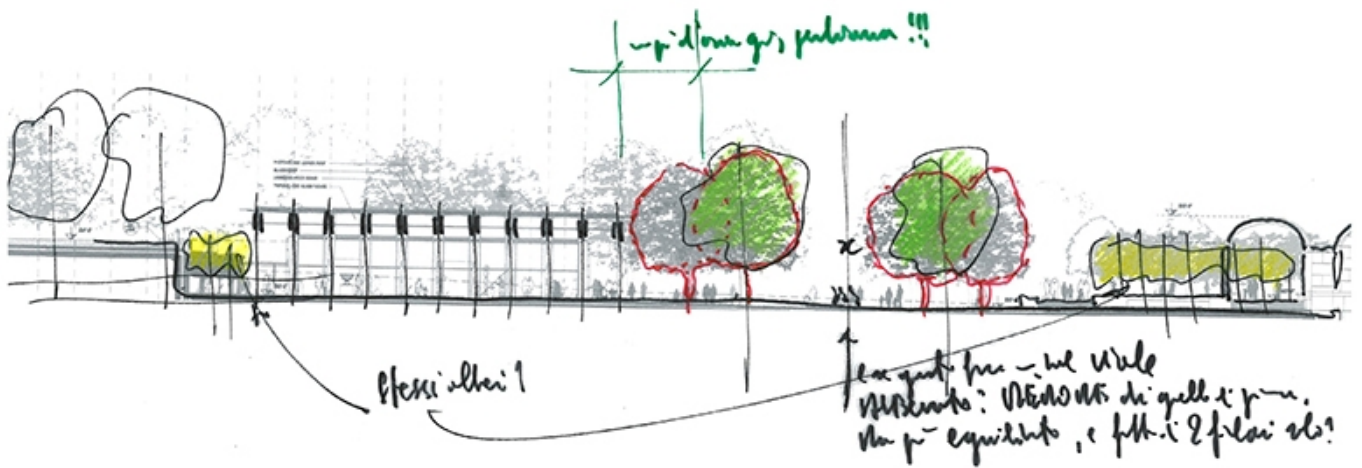

Titolo	-
Scala	-
Dimensione	A4
Data	2009/08/01
Numero Disegno	-
Codice disegno	Kim-rp_810
Autore	Renzo Piano
Copyright	Renzo Piano

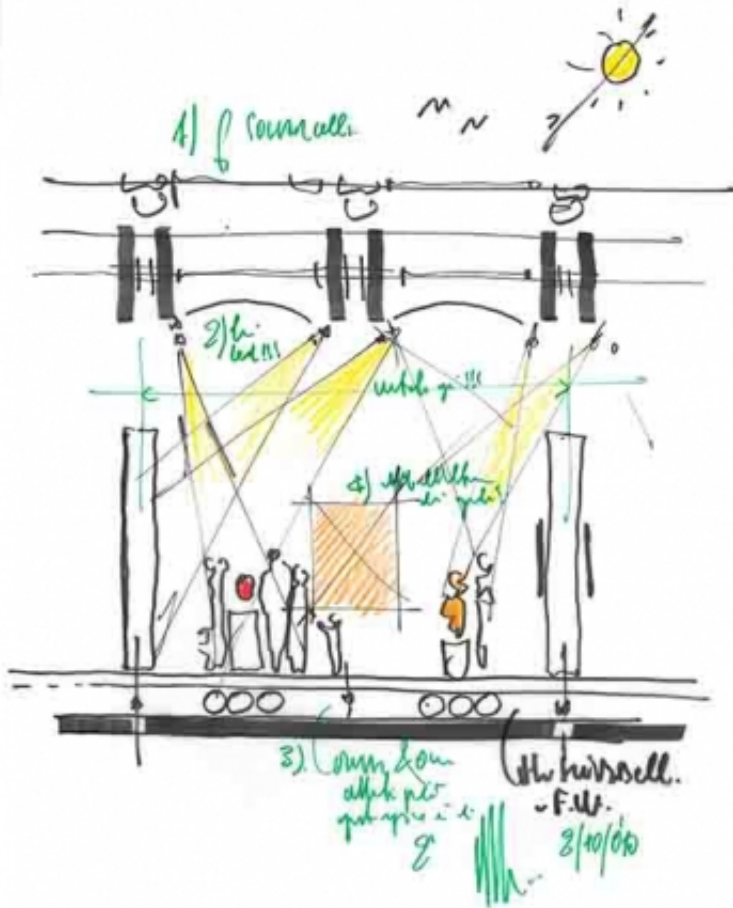

Titolo	Exhibition room
Scala	-
Dimensione	28x35.5 cm
Data	2010/10/02
Numero Disegno	-
Codice disegno	Kim-rp_934

Autore	Renzo Piano
--------	-------------

Copyright	Renzo Piano
-----------	-------------

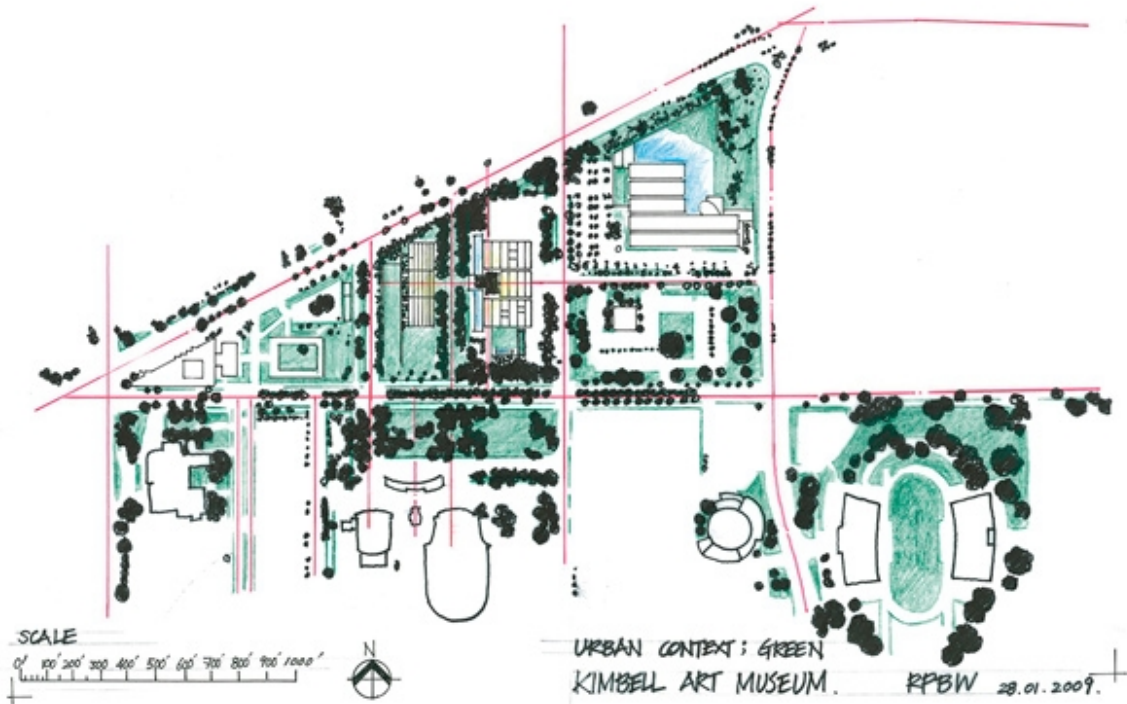

Titolo	Urban context green (Contesto urbano verde)
Scala	N/A
Dimensione	A3
Data	2009/01/28
Numero Disegno	-
Codice disegno	KAM_E_027
Autore	Renzo Piano Building Workshop
Copyright	Renzo Piano Building Workshop

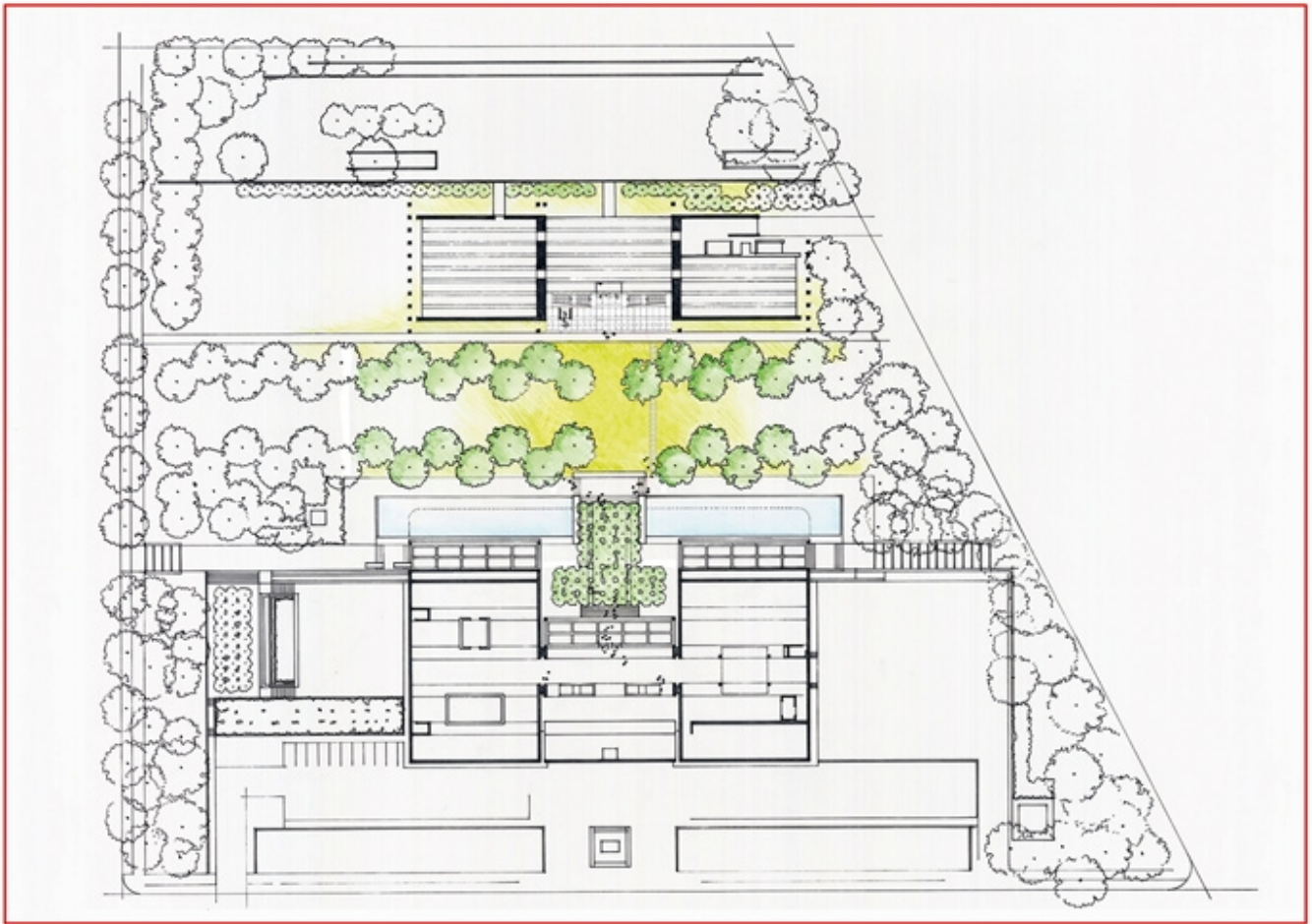

Titolo	-
Scala	N/A
Data	2012/09/01
Numero Disegno	-
Codice disegno	KAM_E_148
Autore	Renzo Piano Building Workshop
Copyright	Renzo Piano Building Workshop

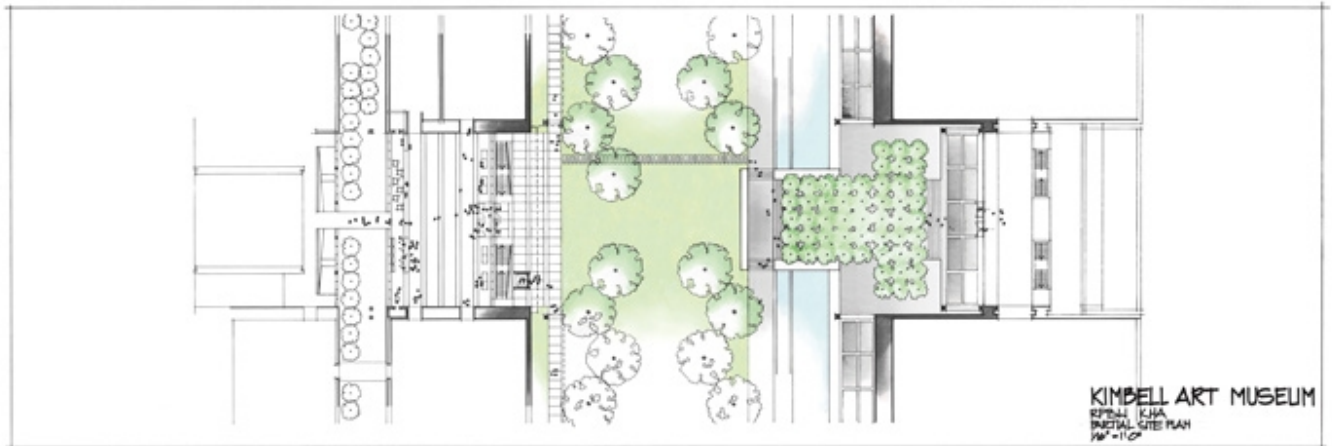

Titolo	-
Scala	1/16"=1'-0" il disegno in originale misura 122x45cm
Dimensione	122 x 45 cm
Data	2012/09/11
Numero Disegno	-
Codice disegno	KAM_E_147
Autore	Renzo Piano Building Workshop
Copyright	Renzo Piano Building Workshop

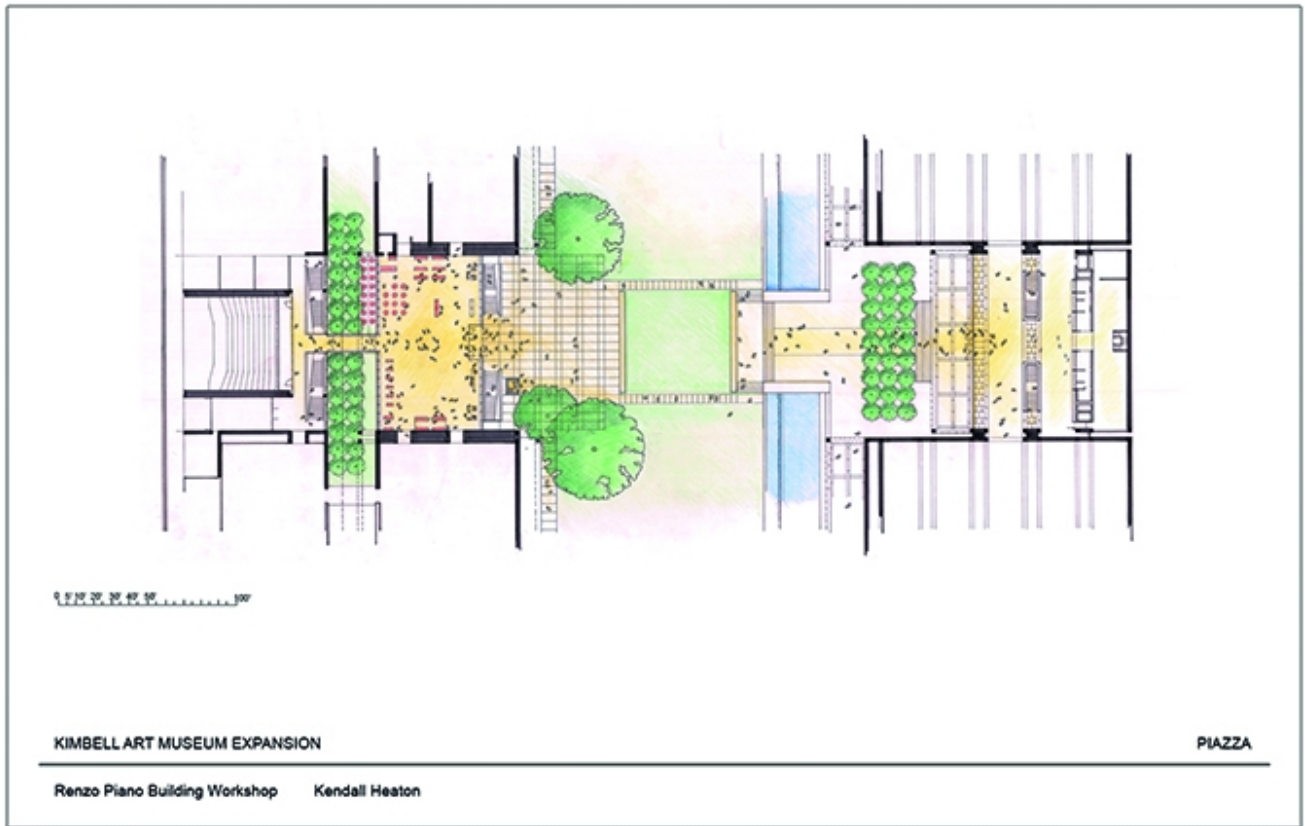

Titolo	Piazza
Scala	N/A
Data	2011/07/01
Numero Disegno	-
Codice disegno	KAM_E_151
Autore	Renzo Piano Building Workshop
Copyright	Renzo Piano Building Workshop

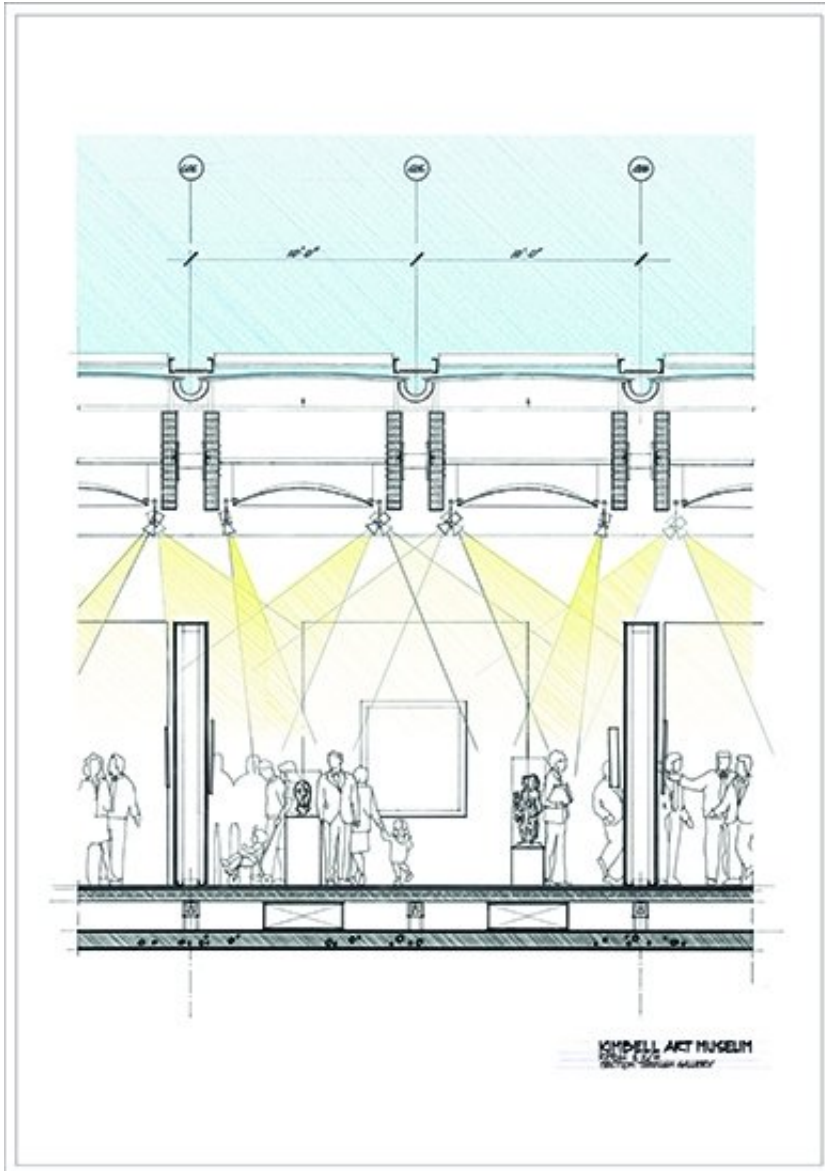

Titolo

Section through gallery

Scala

N/A

Data

2011/07/01

Numero Disegno

-

Codice disegno

KAM_E_152

Autore	Renzo Piano Building Workshop
--------	-------------------------------

Copyright	Renzo Piano Building Workshop
-----------	-------------------------------

Codice disegno

KAM_E_025

Autore

Renzo Piano Building Workshop

Copyright

Renzo Piano Building Workshop

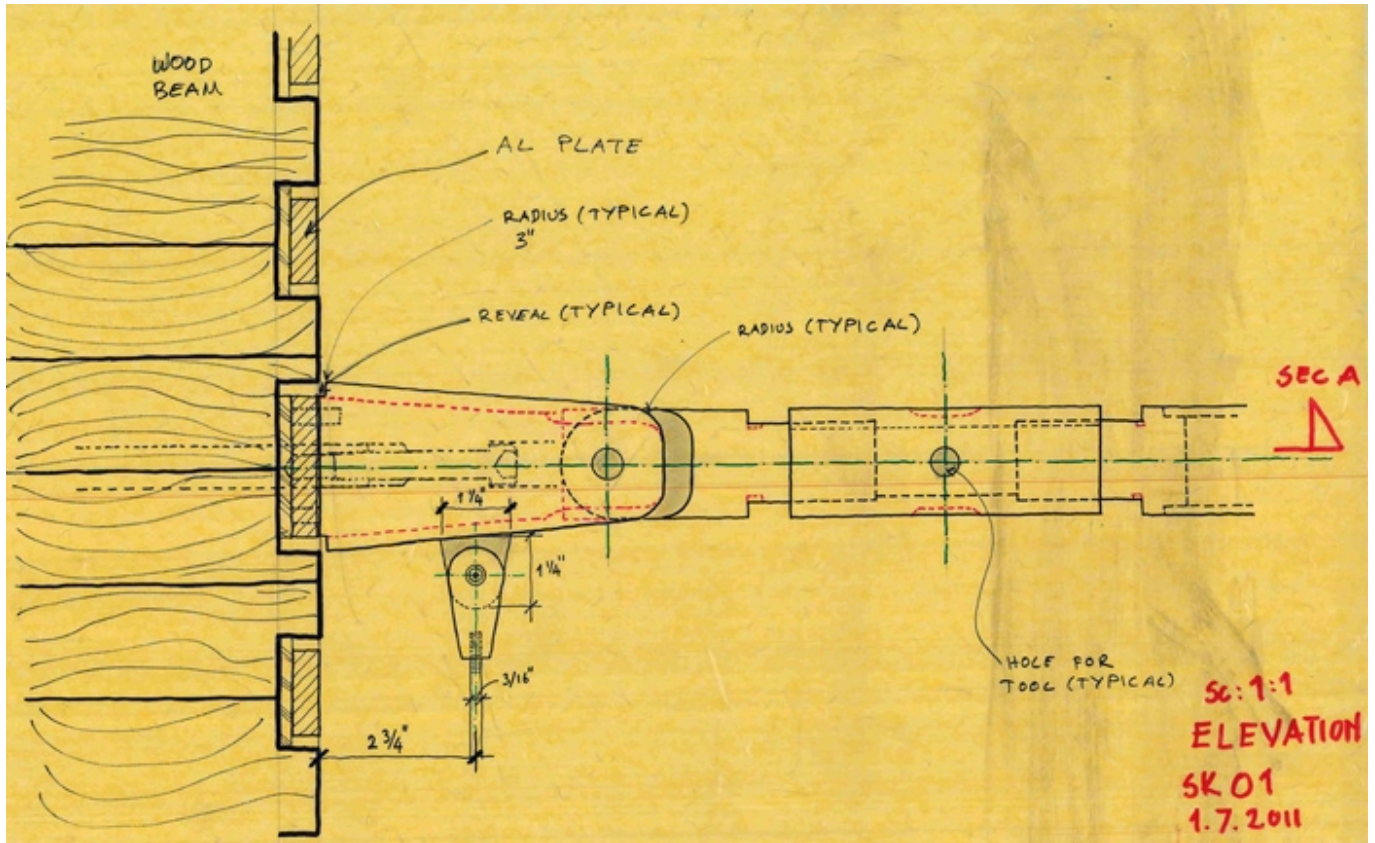

Titolo	(Dettaglio)
Scala	N/A
Dimensione	A2
Data	2011/07/01
Numero Disegno	-
Codice disegno	KAM_E_149
Autore	Renzo Piano Building Workshop
Copyright	Renzo Piano Building Workshop

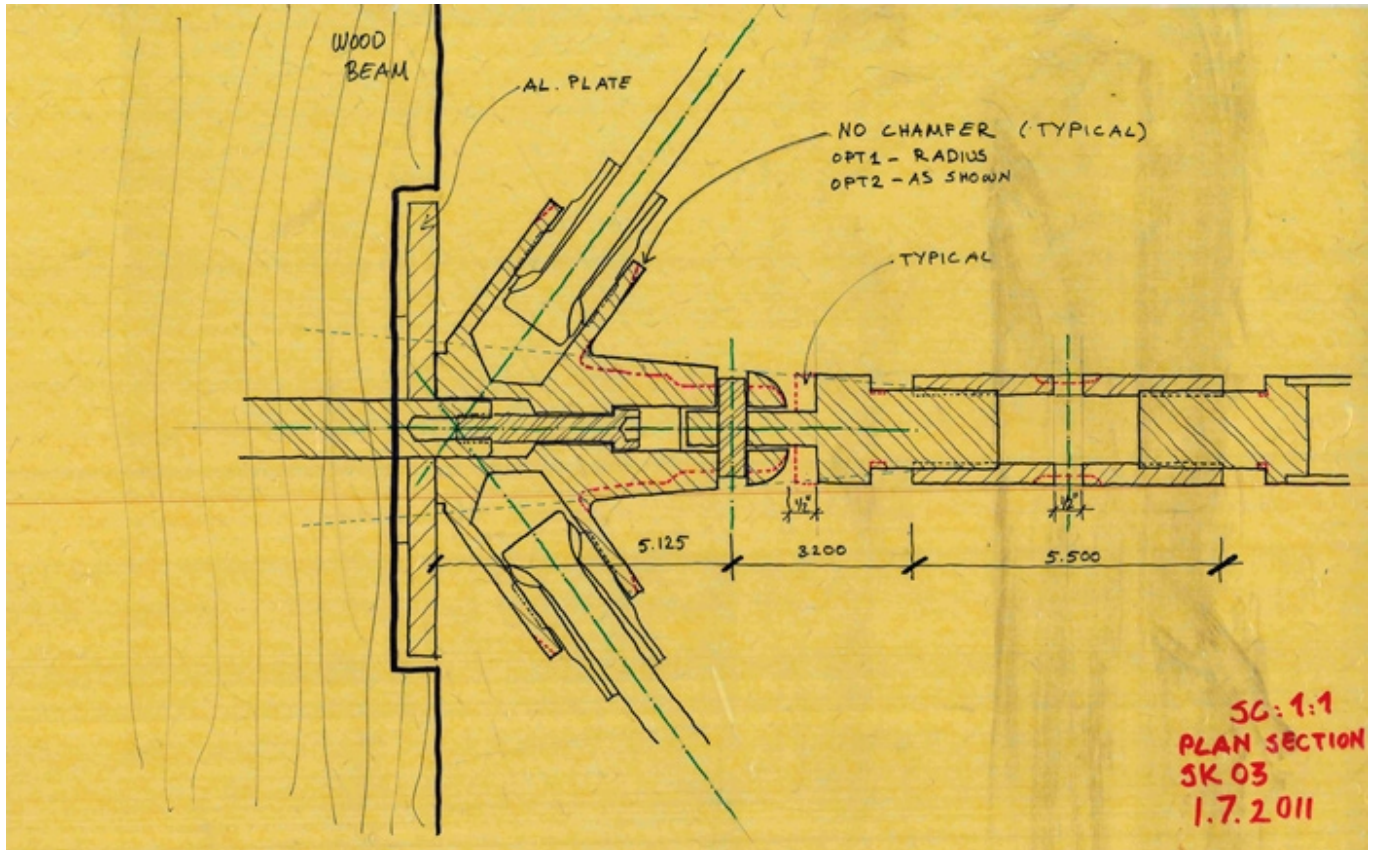

Titolo	Plan section sk 03
Scala	N/A
Dimensione	A2
Data	2011/07/01
Numero Disegno	-
Codice disegno	KAM_E_150
Autore	Renzo Piano Building Workshop
Copyright	Renzo Piano Building Workshop



KIMBELL ART MUSEUM
Renzo Piano Building Workshop

Site Plan
November 19th, 2013

Titolo	Site plan
Scala	NTS
Data	2013/11/19
Numero Disegno	-
Codice disegno	KAM_DW_297
Autore	Renzo Piano Building Workshop
Copyright	Renzo Piano Building Workshop

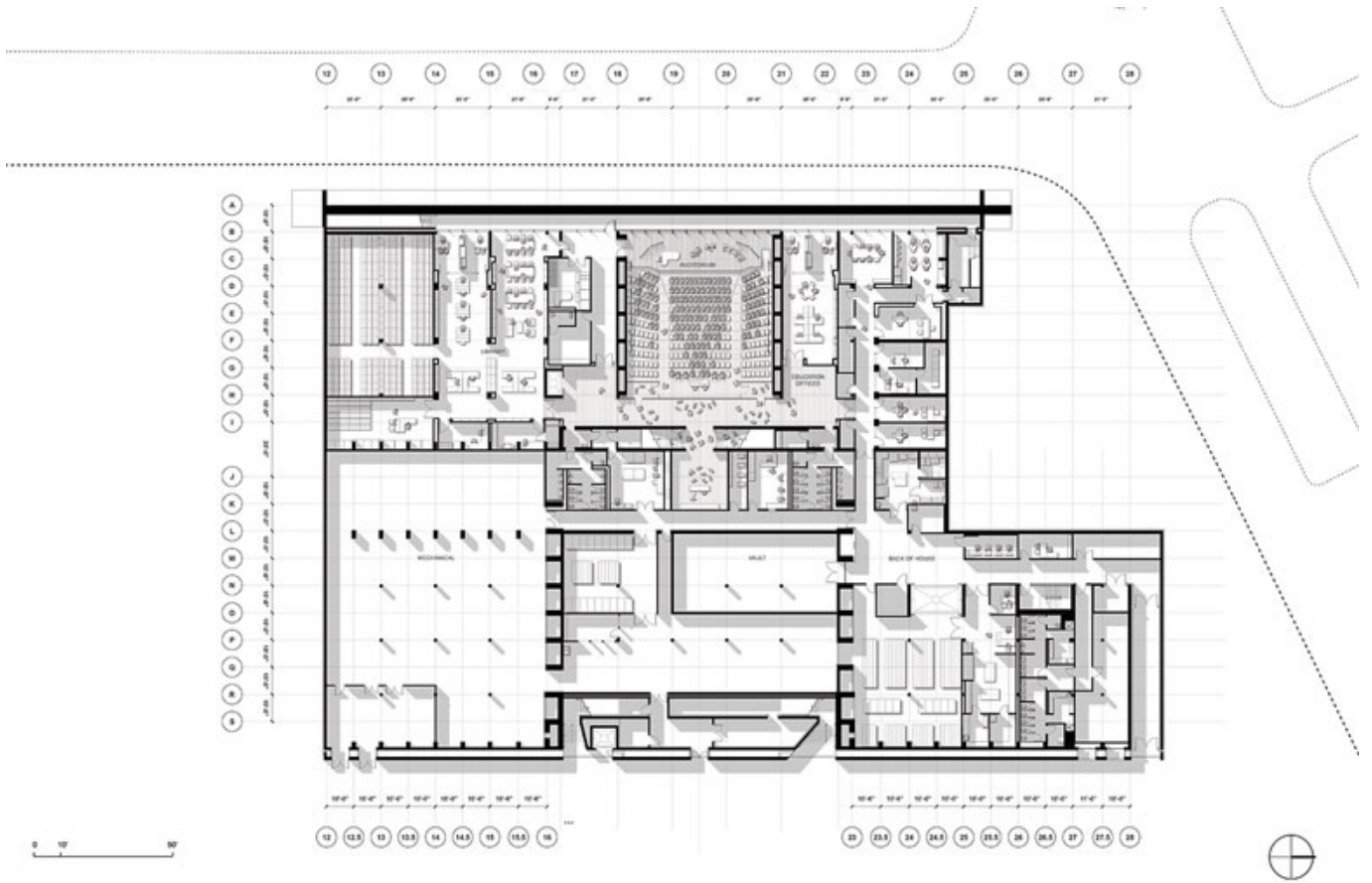

KIMBELL ART MUSEUM
Renzo Piano Building Workshop

Plan Level B1
October 28th, 2013

Titolo	Plan level B1
Scala	NTS
Data	2013/10/28
Numero Disegno	-
Codice disegno	KAM_DW_298
Autore	Renzo Piano Building Workshop
Copyright	Renzo Piano Building Workshop

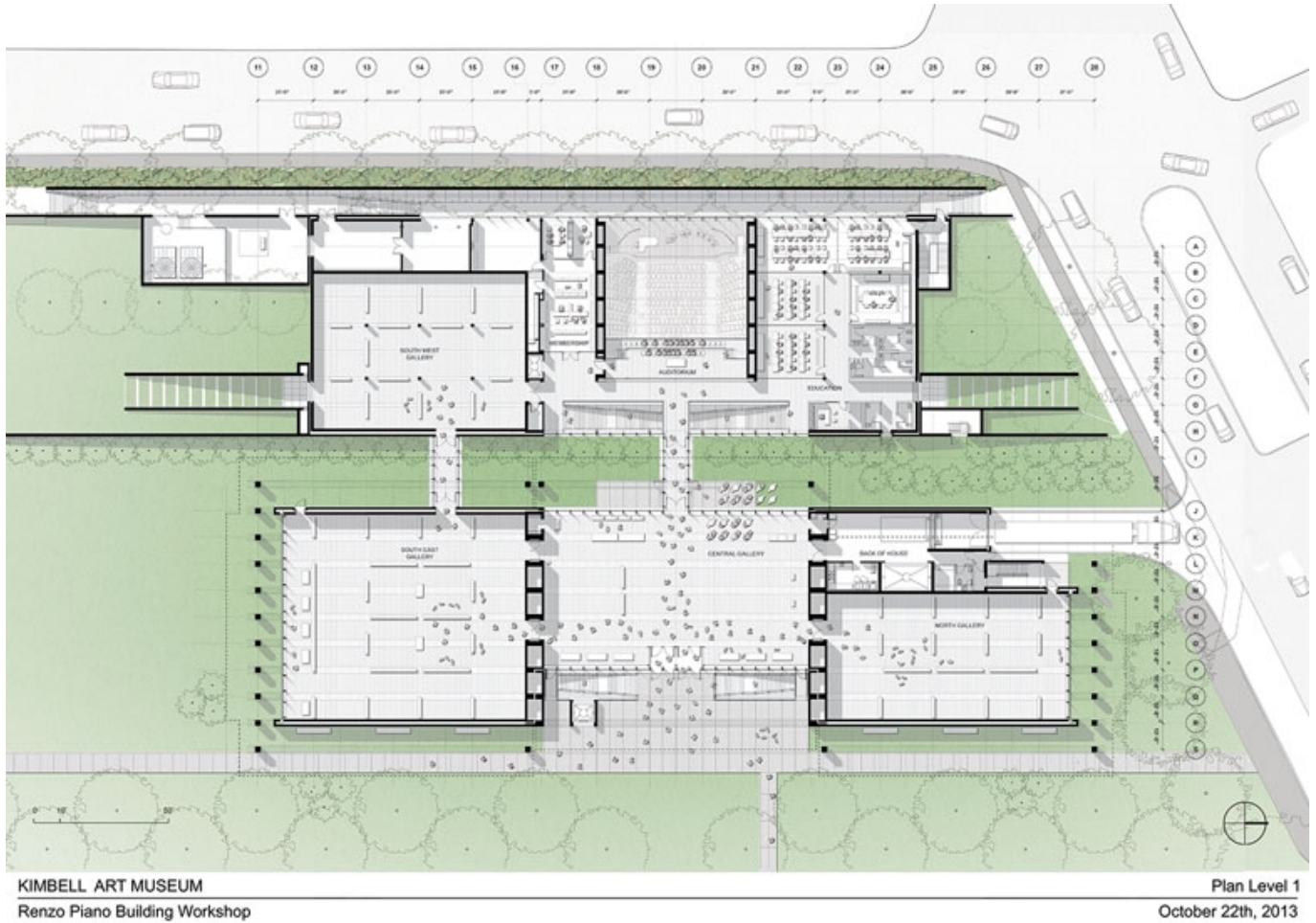

Titolo	Plan level 1
Scala	NTS
Data	2013/10/22
Numero Disegno	-
Codice disegno	KAM_DW_299
Autore	Renzo Piano Building Workshop
Copyright	Renzo Piano Building Workshop

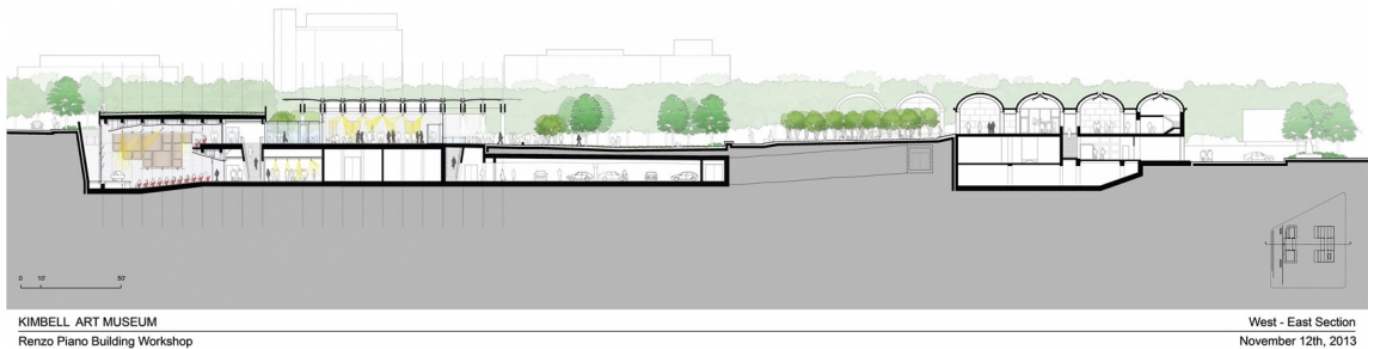

Titolo	West - East Section
Scala	NTS
Data	2013/11/19
Numero Disegno	-
Codice disegno	KAM_DW_300
Autore	Renzo Piano Building Workshop
Copyright	Renzo Piano Building Workshop

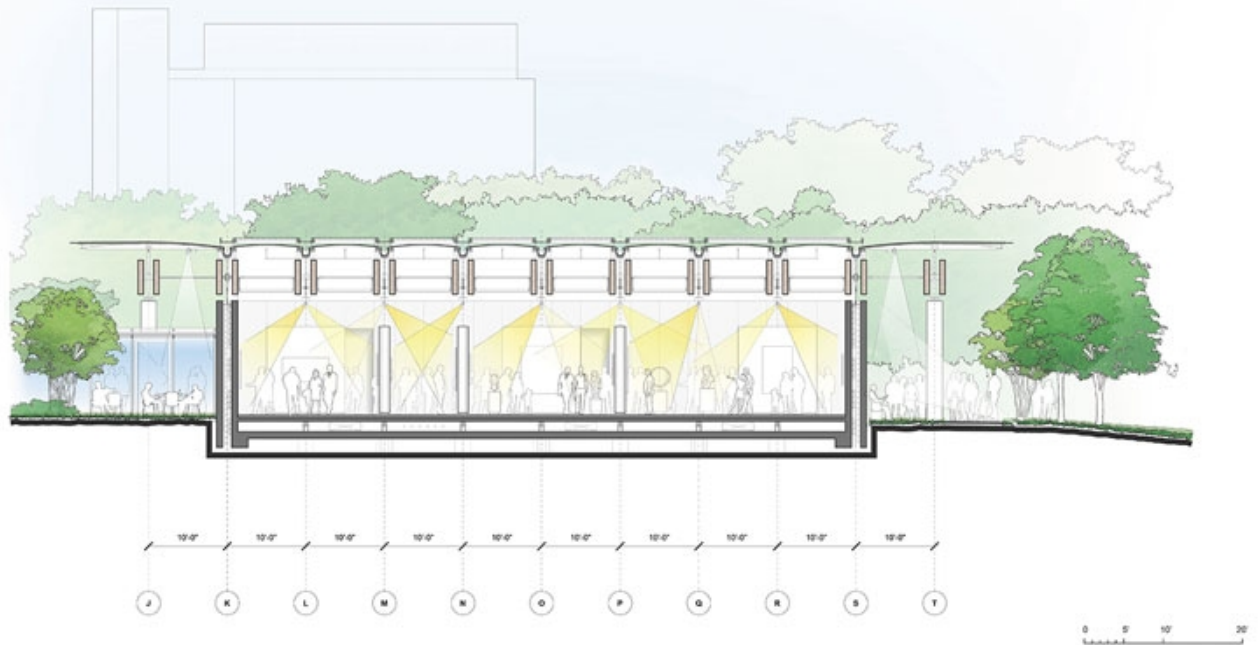

KIMBELL ART MUSEUM
Renzo Piano Building Workshop

South Gallery Section
October 16th, 2013

Titolo	South Gallery Section
Scala	NTS
Data	2013/10/16
Numero Disegno	-
Codice disegno	KAM_DW_301
Autore	Renzo Piano Building Workshop
Copyright	Renzo Piano Building Workshop



Titolo	South Elevation
Scala	NTS
Data	2013/11/12
Numero Disegno	-
Codice disegno	KAM_DW_302
Autore	Renzo Piano Building Workshop
Copyright	Renzo Piano Building Workshop



KIMBELL ART MUSEUM
Renzo Piano Building Workshop

South Elevation
October 16th, 2013

Titolo	South Elevation
Scala	NTS
Data	2013/10/16
Numero Disegno	-
Codice disegno	KAM_DW_303
Autore	Renzo Piano Building Workshop
Copyright	Renzo Piano Building Workshop



KIMBELL ART MUSEUM
Renzo Piano Building Workshop

East Elevation
November 6th, 2013

Titolo	East Elevation
Scala	NTS
Data	2013/11/06
Numero Disegno	-
Codice disegno	KAM_DW_304
Autore	Renzo Piano Building Workshop
Copyright	Renzo Piano Building Workshop

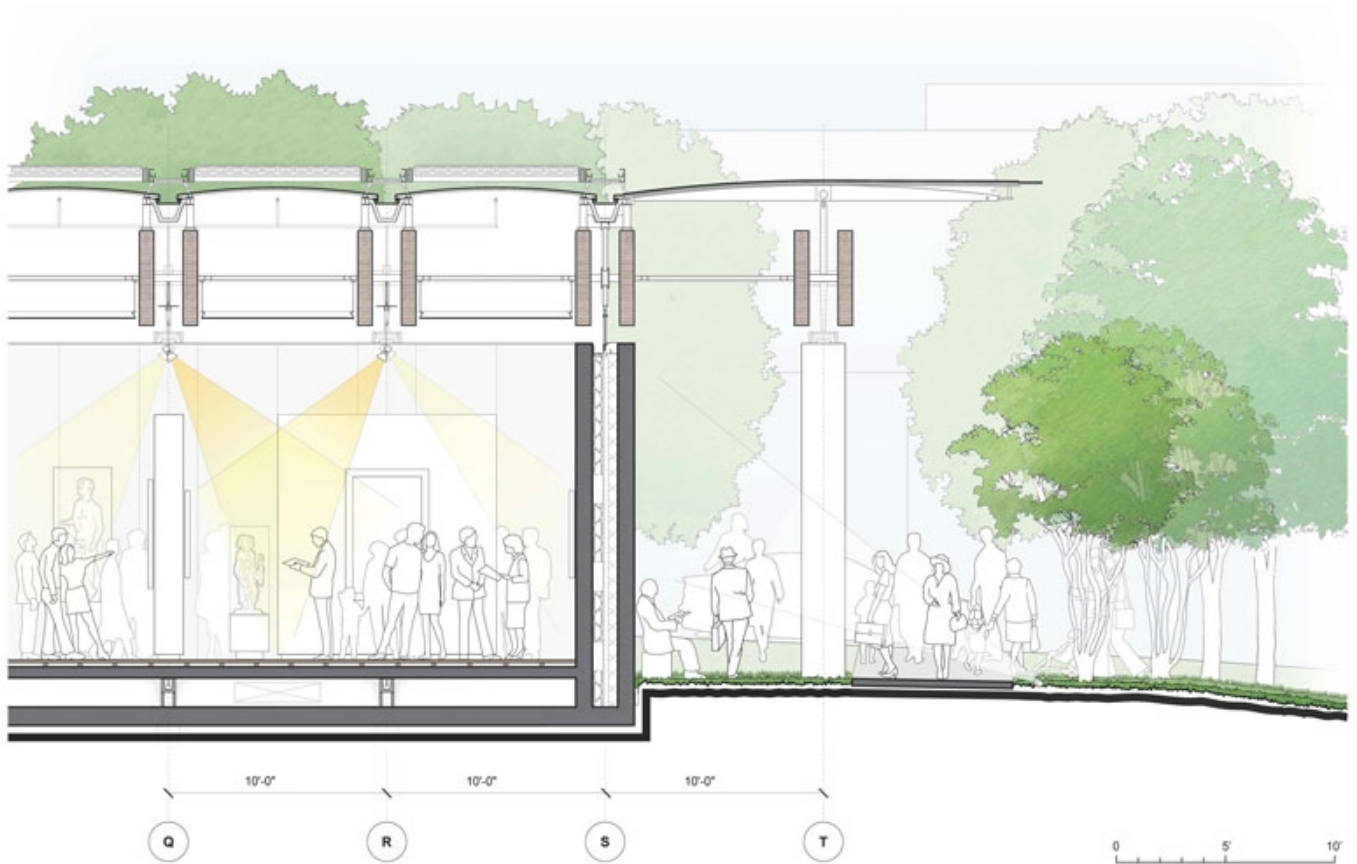

KIMBELL ART MUSEUM
Renzo Piano Building Workshop

South Gallery Wall Section
October 30th, 2013

Titolo South Gallery Wall Section

Scala NTS

Data 2013/10/30

Numero Disegno -

Codice disegno KAM_DW_305

Autore Renzo Piano Building Workshop

Copyright Renzo Piano Building Workshop

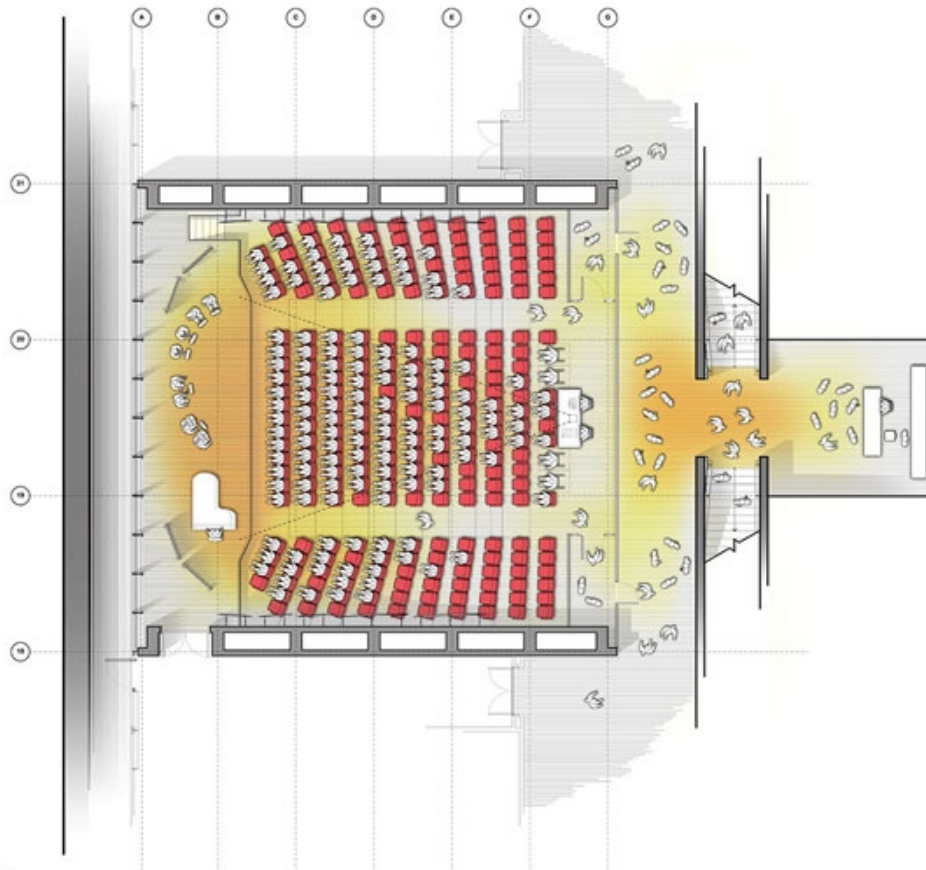

0 1 2 3 4 5 6

KIMBELL ART MUSEUM
Renzo Piano Building Workshop



Auditorium Plan Level B1
October 10th, 2013

Titolo	Auditorium Plan Level B1
Scala	NTS
Data	2013/10/30
Numero Disegno	-
Codice disegno	KAM_DW_306
Autore	Renzo Piano Building Workshop
Copyright	Renzo Piano Building Workshop



KIMBELL ART MUSEUM
Renzo Piano Building Workshop

Auditorium Section
October 25th, 2013

Titolo	Auditorium Section
Scala	NTS
Data	2013/10/25
Numero Disegno	-
Codice disegno	KAM_DW_307
Autore	Renzo Piano Building Workshop
Copyright	Renzo Piano Building Workshop

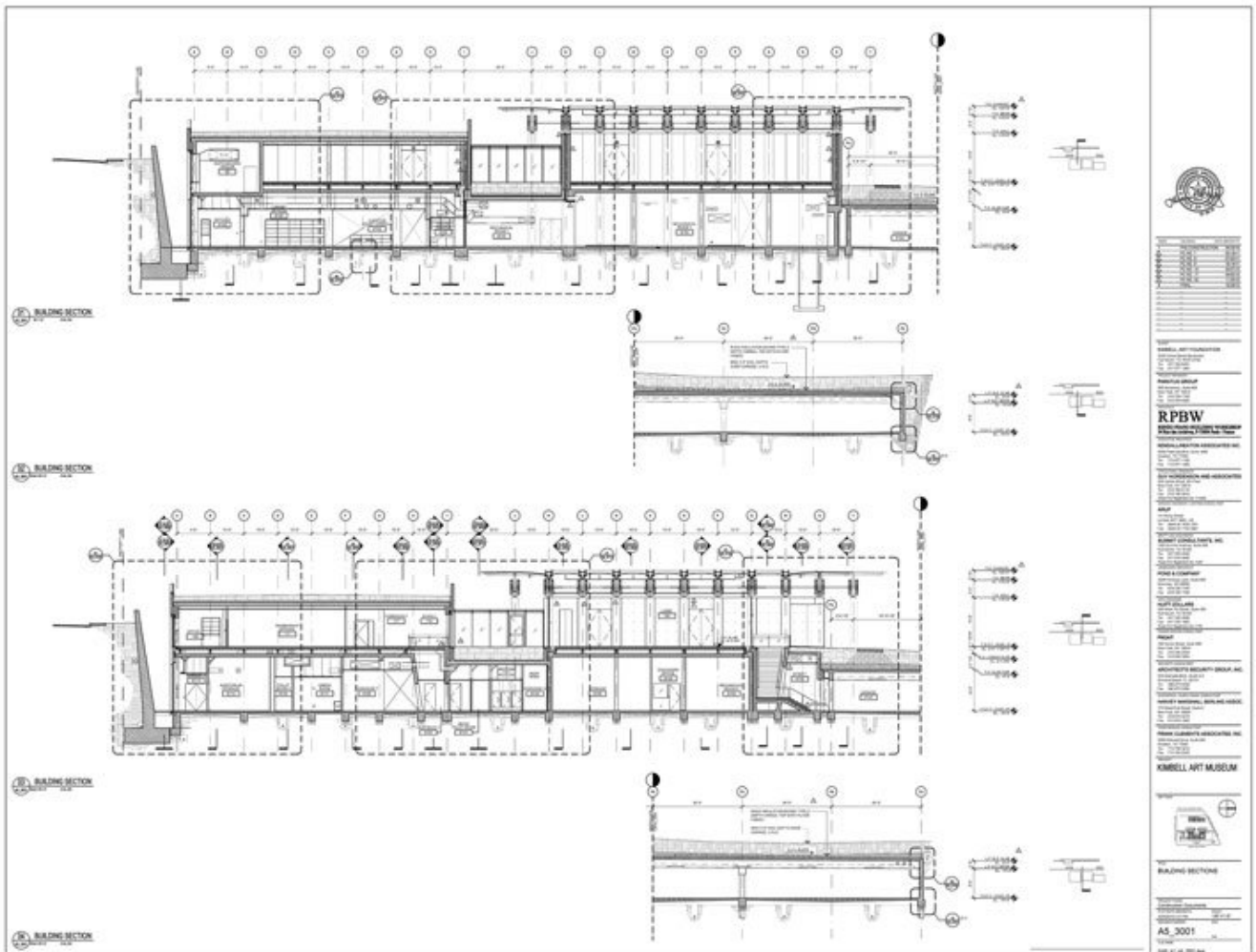

Titolo Building sections

Scala 1/8"=1'-0"

Data 2013/12/30

Numero Disegno A5_3001

Codice disegno KAM_DW_047

Autore Renzo Piano Building Workshop

Copyright Renzo Piano Building Workshop

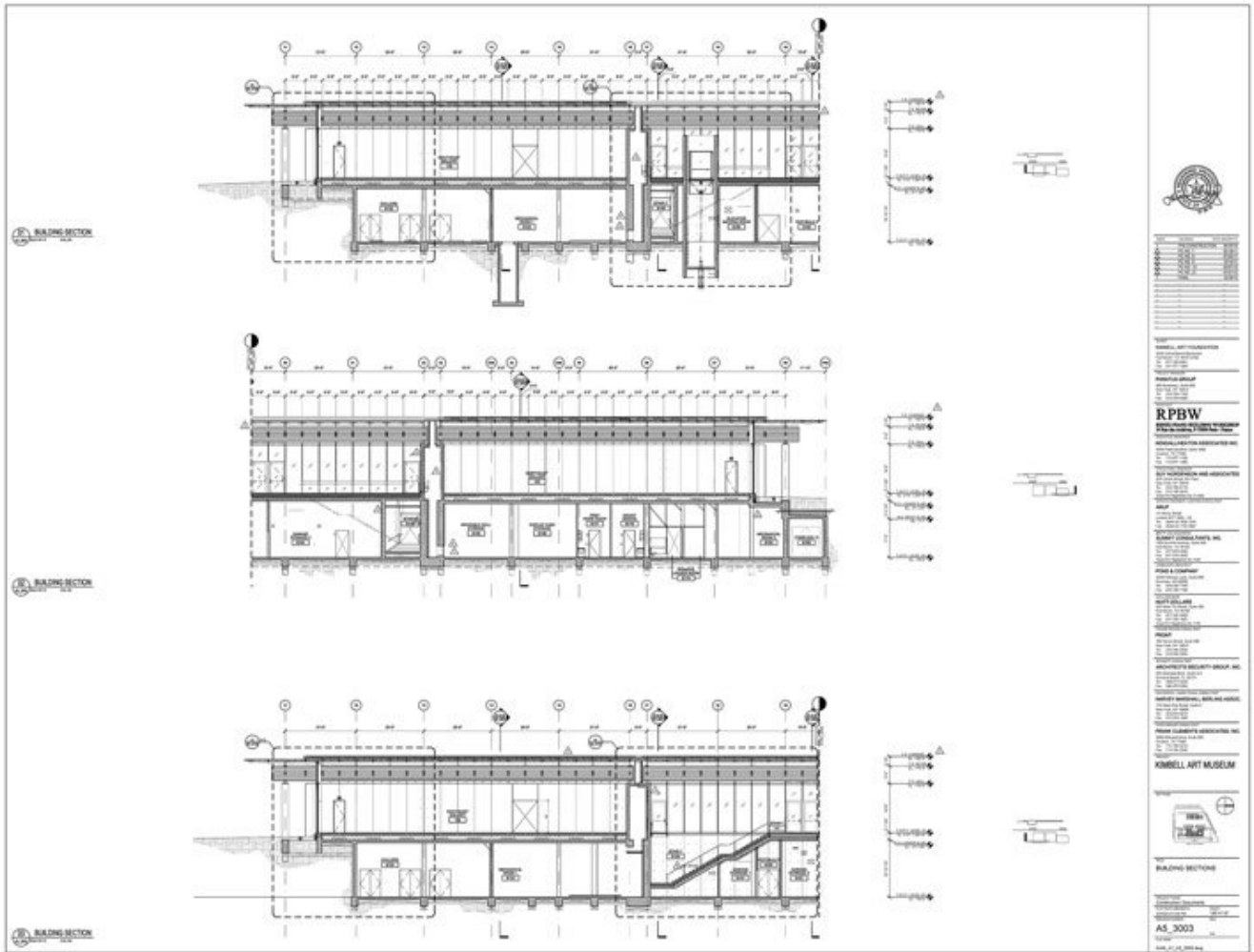

Titolo Building sections

Scala 1/8"=1'-0"

Data 2013/12/30

Numero Disegno A5_3003

Codice disegno KAM_DW_049

Autore Renzo Piano Building Workshop

Copyright

Renzo Piano Building Workshop

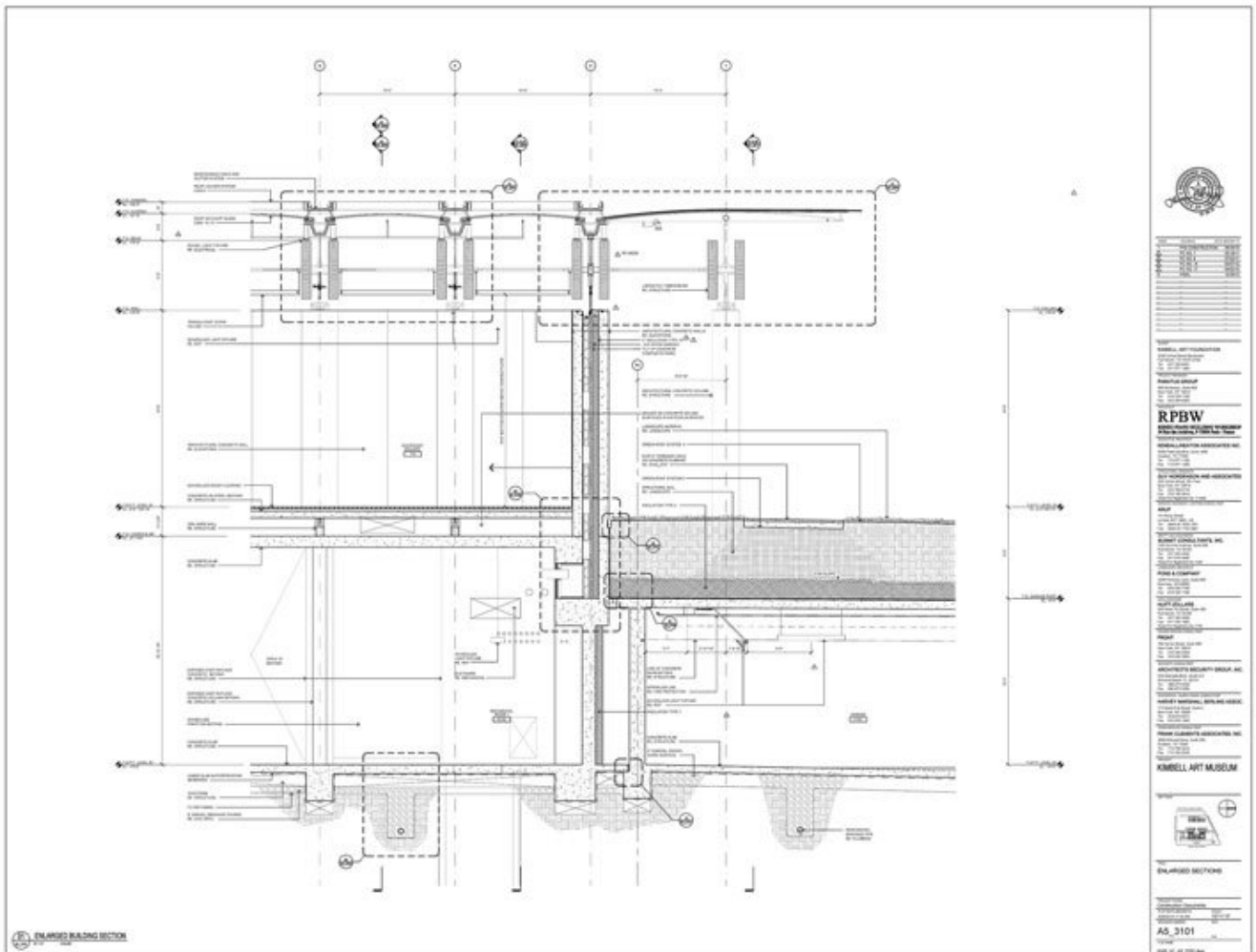

Titolo Enlarged section

Scala $1/2" = 1'-0"$

Data 2013/12/30

Numero Disegno A5_3101

Codice disegno KAM_DW_064

Autore	Renzo Piano Building Workshop
--------	-------------------------------

Copyright	Renzo Piano Building Workshop
-----------	-------------------------------

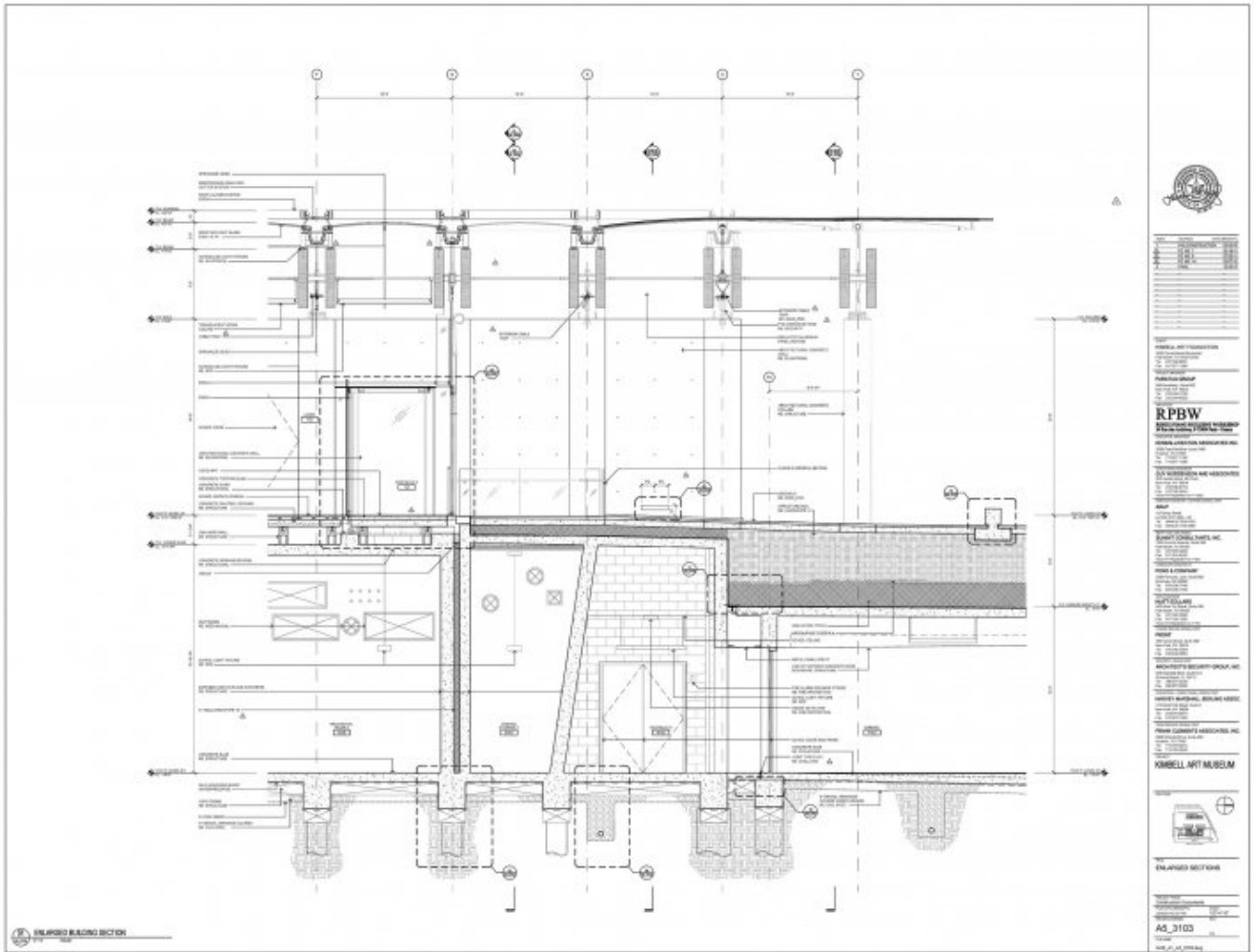

Titolo Enlarged section

Scala 1/2"=1'-0"

Data 2013/12/30

Numero Disegno A5_3103

Codice disegno KAM_DW_066

Autore	Renzo Piano Building Workshop
--------	-------------------------------

Copyright	Renzo Piano Building Workshop
-----------	-------------------------------

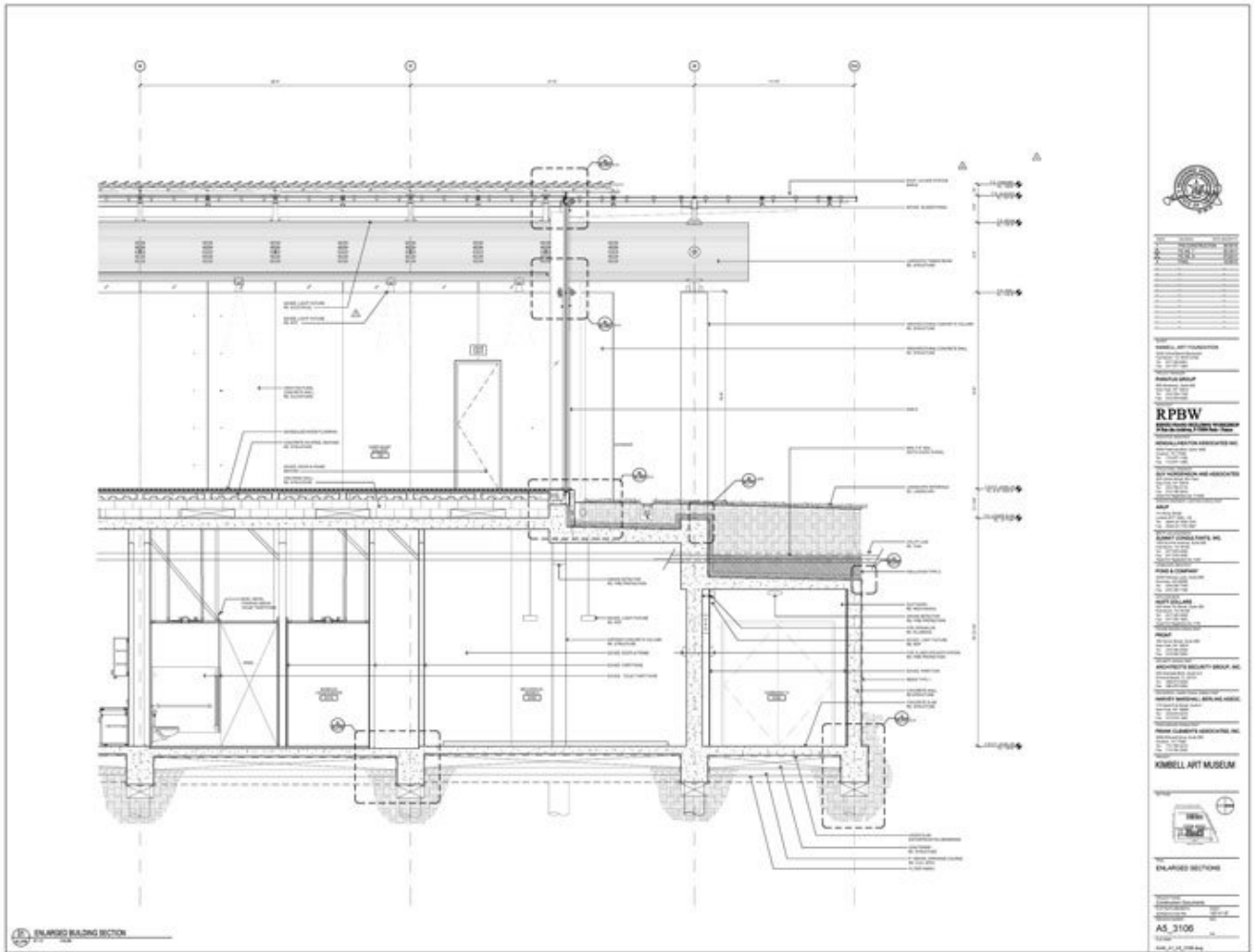

Titolo Enlarged section

Scala 1/2"=1'-0"

Data 2013/12/30

Numero Disegno A5_3106

Codice disegno KAM_DW_069

Autore Renzo Piano Building Workshop

Copyright

Renzo Piano Building Workshop

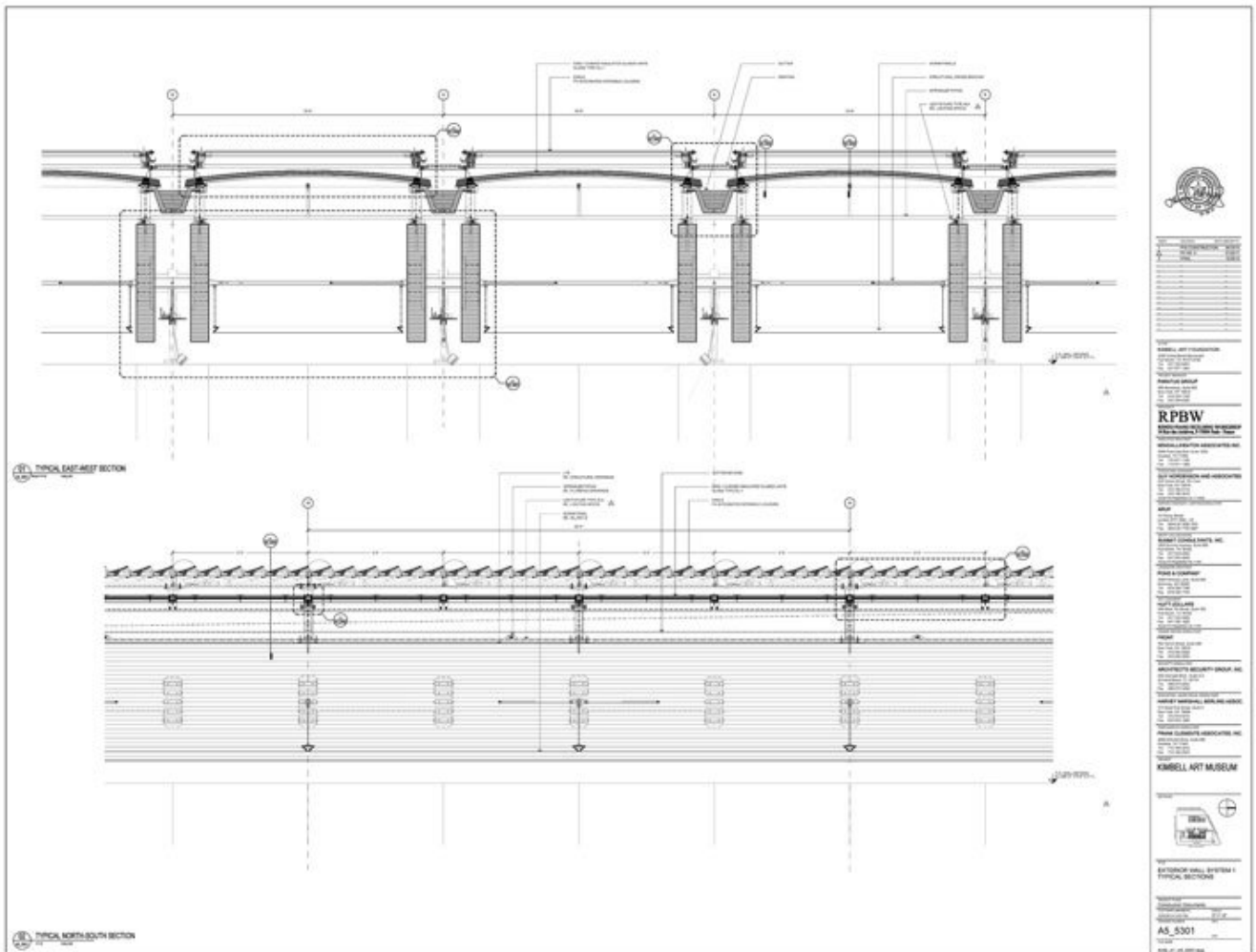

Titolo Exterior wall system 1 typical sections

Scala 3"=1'-0"

Data 2013/12/30

Numero Disegno A5_5301

Codice disegno KAM_DW_173

Autore	Renzo Piano Building Workshop
--------	-------------------------------

Copyright	Renzo Piano Building Workshop
-----------	-------------------------------

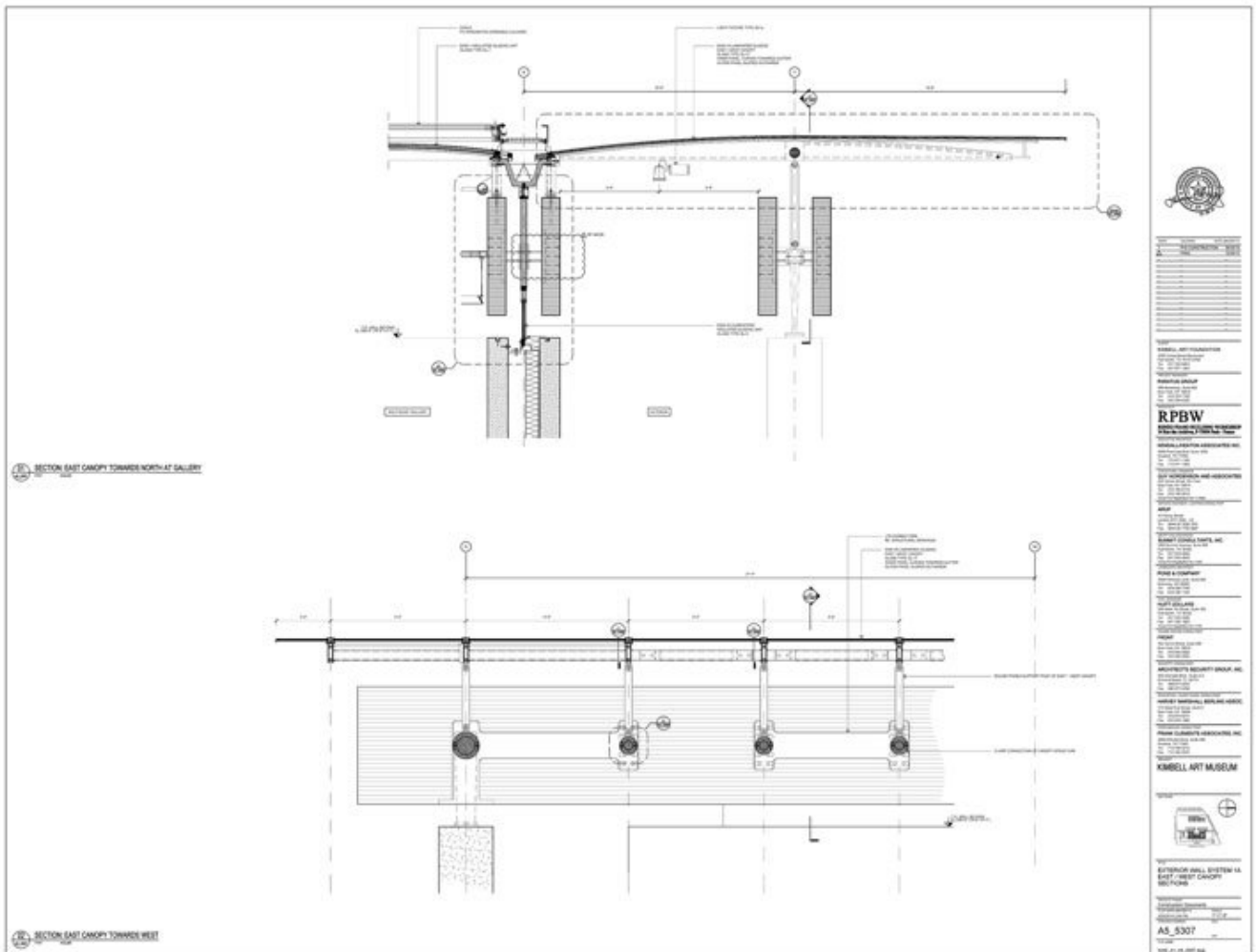

Titolo Exterior wall system 1a east / west canopy sections

Scala 1"=1'-0"

Data 2013/12/30

Numero Disegno A5_5307

Codice disegno KAM_DW_176

Autore	Renzo Piano Building Workshop
--------	-------------------------------

Copyright	Renzo Piano Building Workshop
-----------	-------------------------------

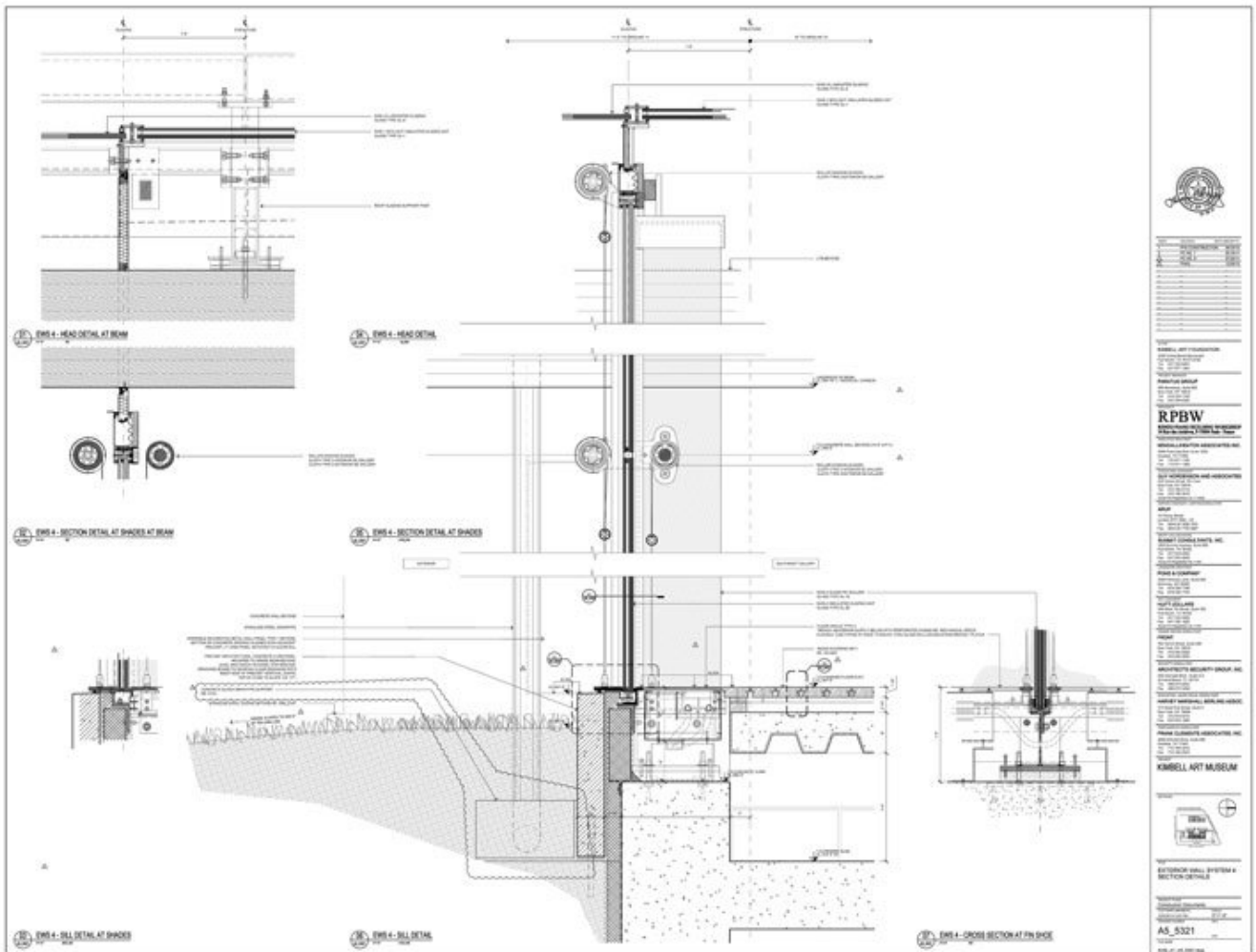

Titolo Exterior wall system 4 section details

Scala 3"=1'-0"

Data 2013/12/30

Numero Disegno A5_5321

Codice disegno KAM_DW_181

Autore Renzo Piano Building Workshop

Copyright

Renzo Piano Building Workshop

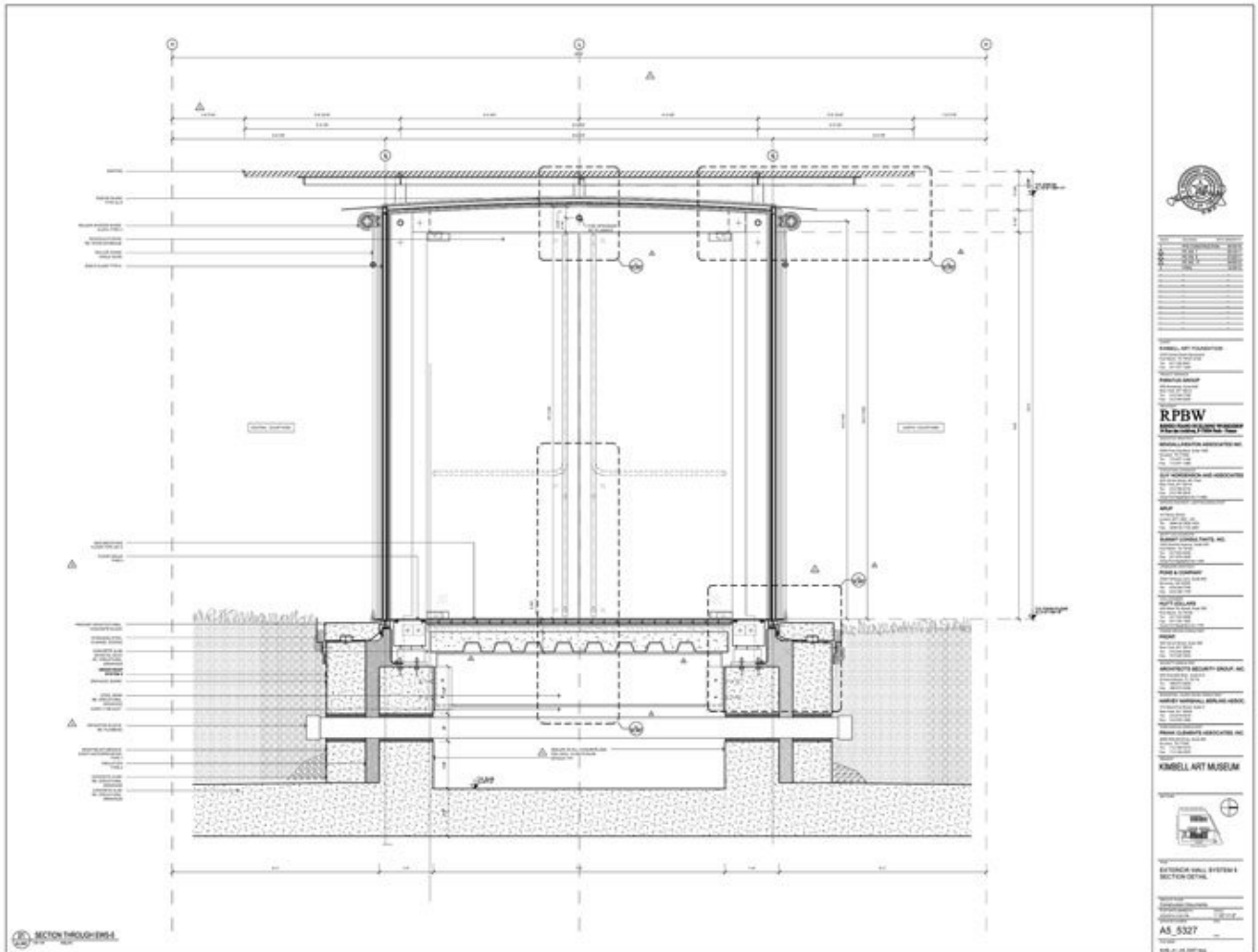

Titolo Exterior wall system 5 section details

Scala 1 -1/2"=1'-0

Data 2013/12/30

Numero Disegno A5_5327

Codice disegno KAM_DW_182

Autore Renzo Piano Building Workshop

Copyright

Renzo Piano Building Workshop

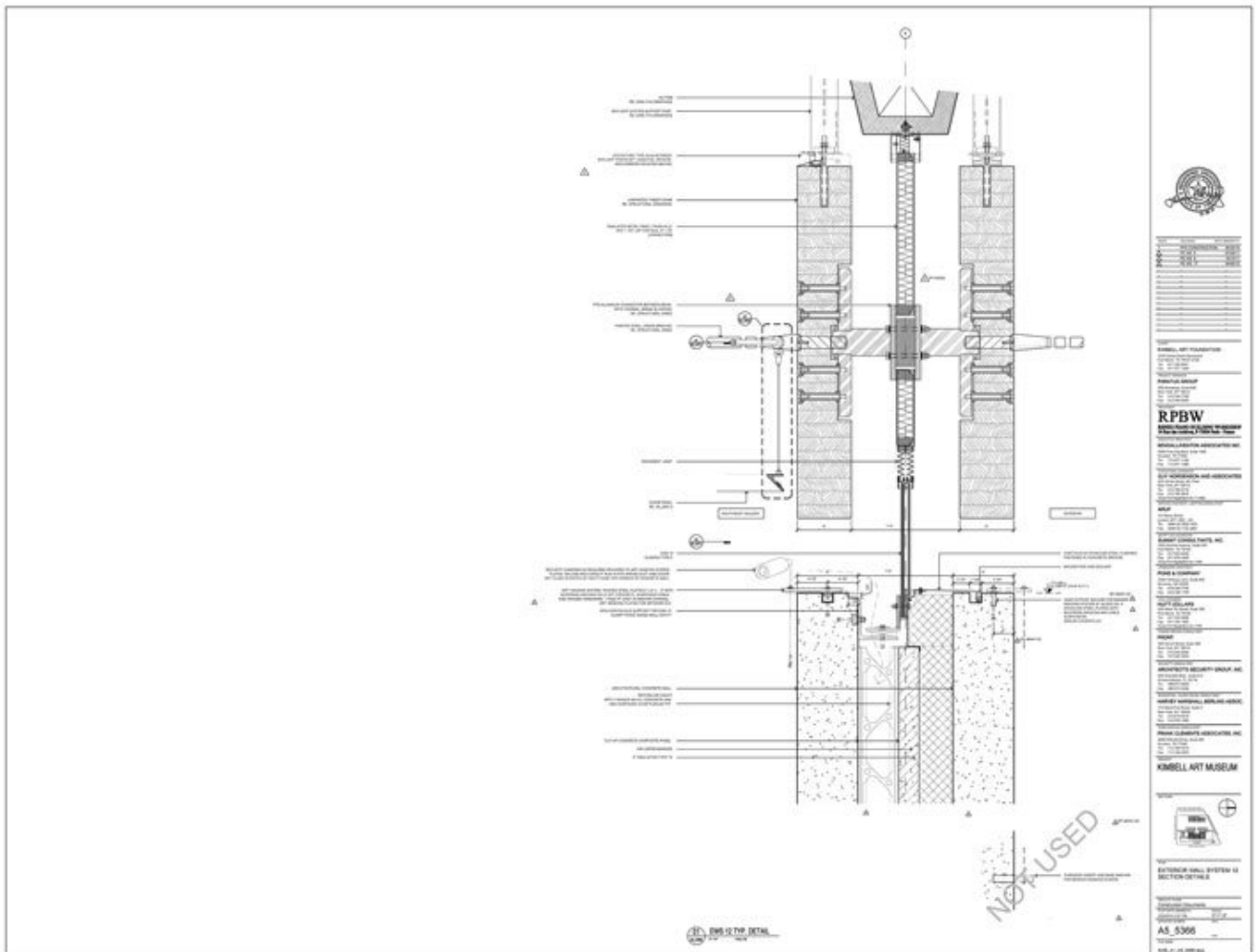

Titolo Exterior wall system 12 section details

Scala 3"=1'-0

Data 2013/12/30

Numero Disegno A5_5366

Codice disegno KAM_DW_195

Autore Renzo Piano Building Workshop

Copyright

Renzo Piano Building Workshop

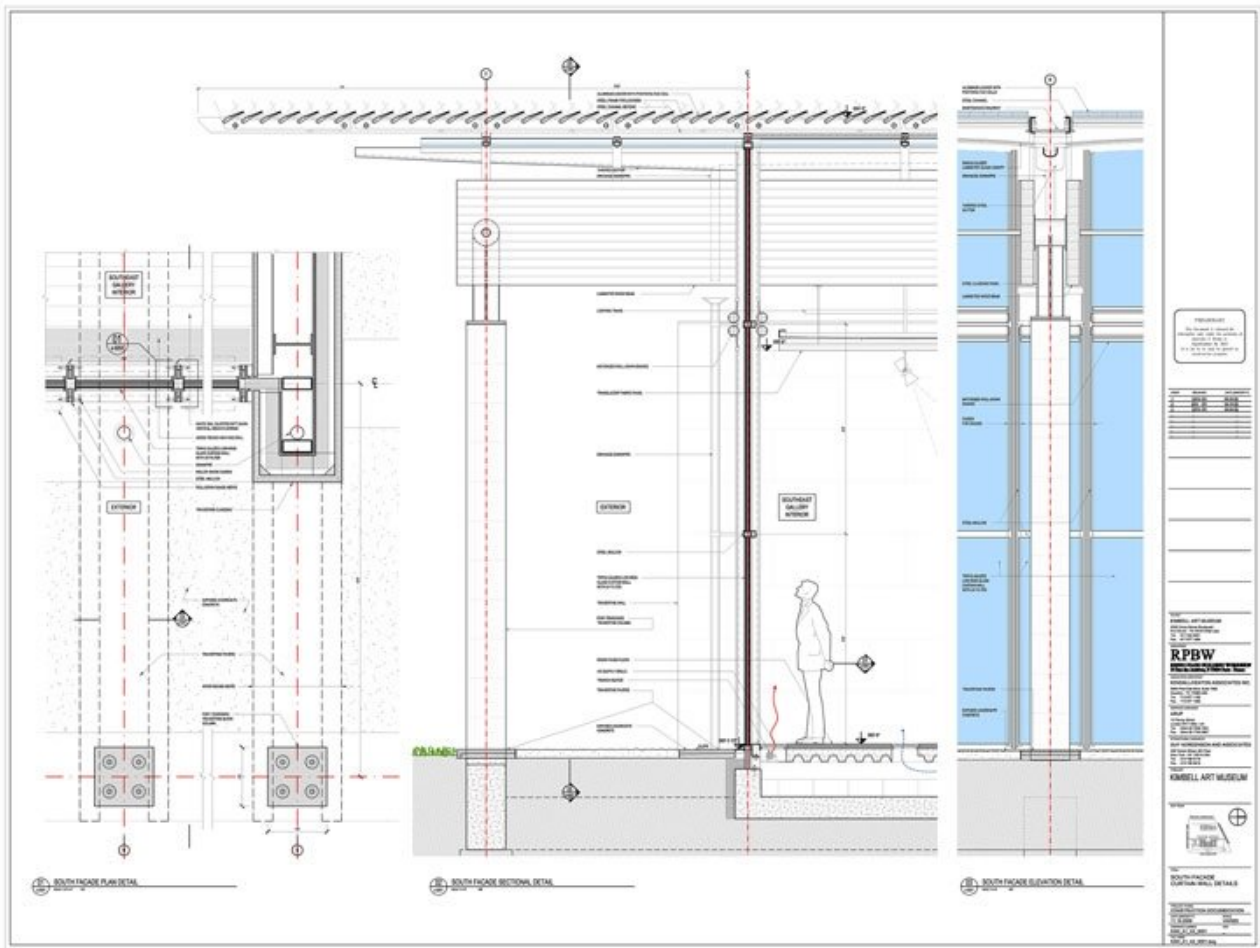

Titolo	South Facade - Curtain Wall Details
Scala	NTS
Data	2013/11/16
Numero Disegno	-
Codice disegno	KAM_DW_308
Autore	Renzo Piano Building Workshop
Copyright	Renzo Piano Building Workshop

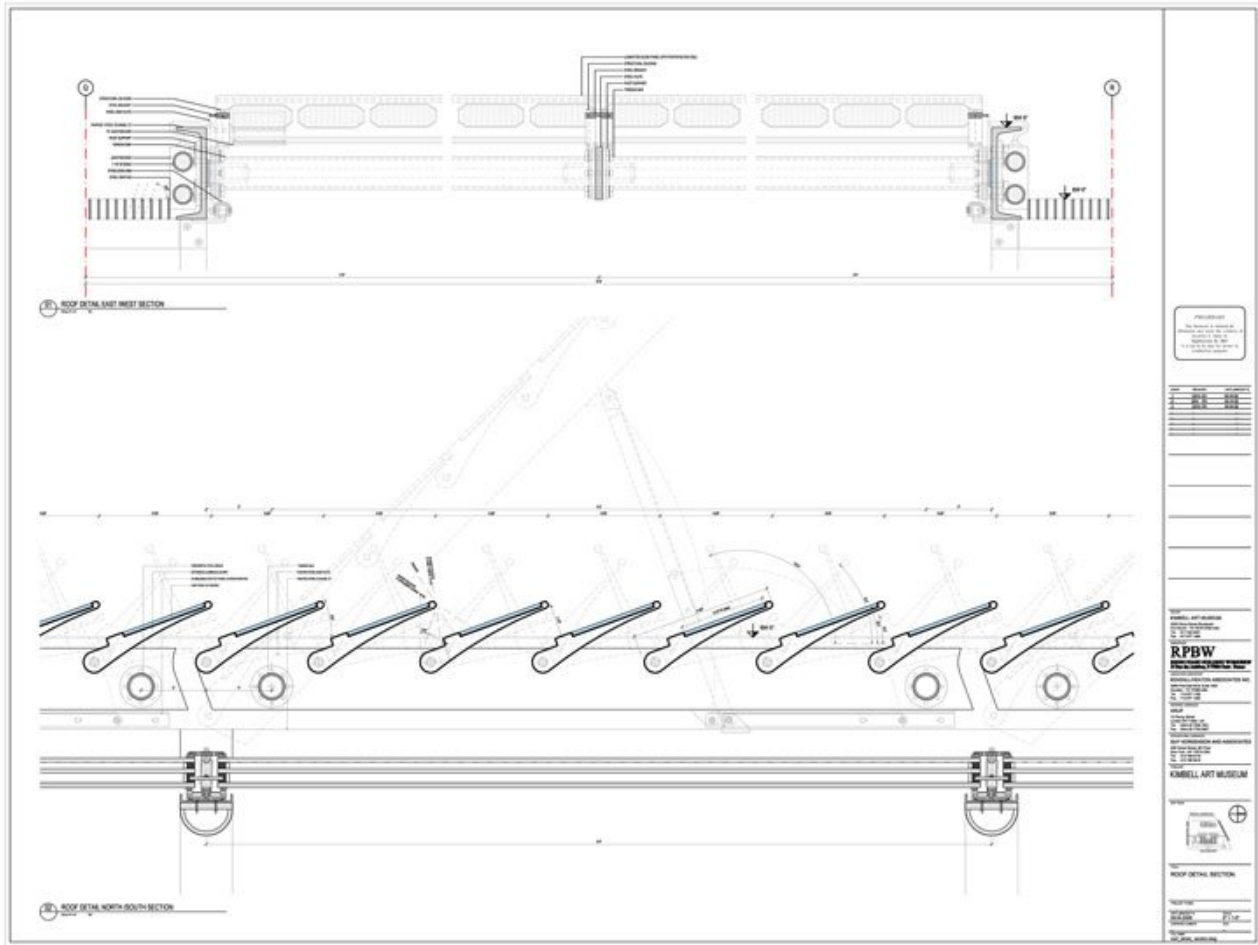

Titolo	Roof Detail Section
Scala	NTS
Data	2009/08/04
Numero Disegno	-
Codice disegno	KAM_DW_309
Autore	Renzo Piano Building Workshop
Copyright	Renzo Piano Building Workshop

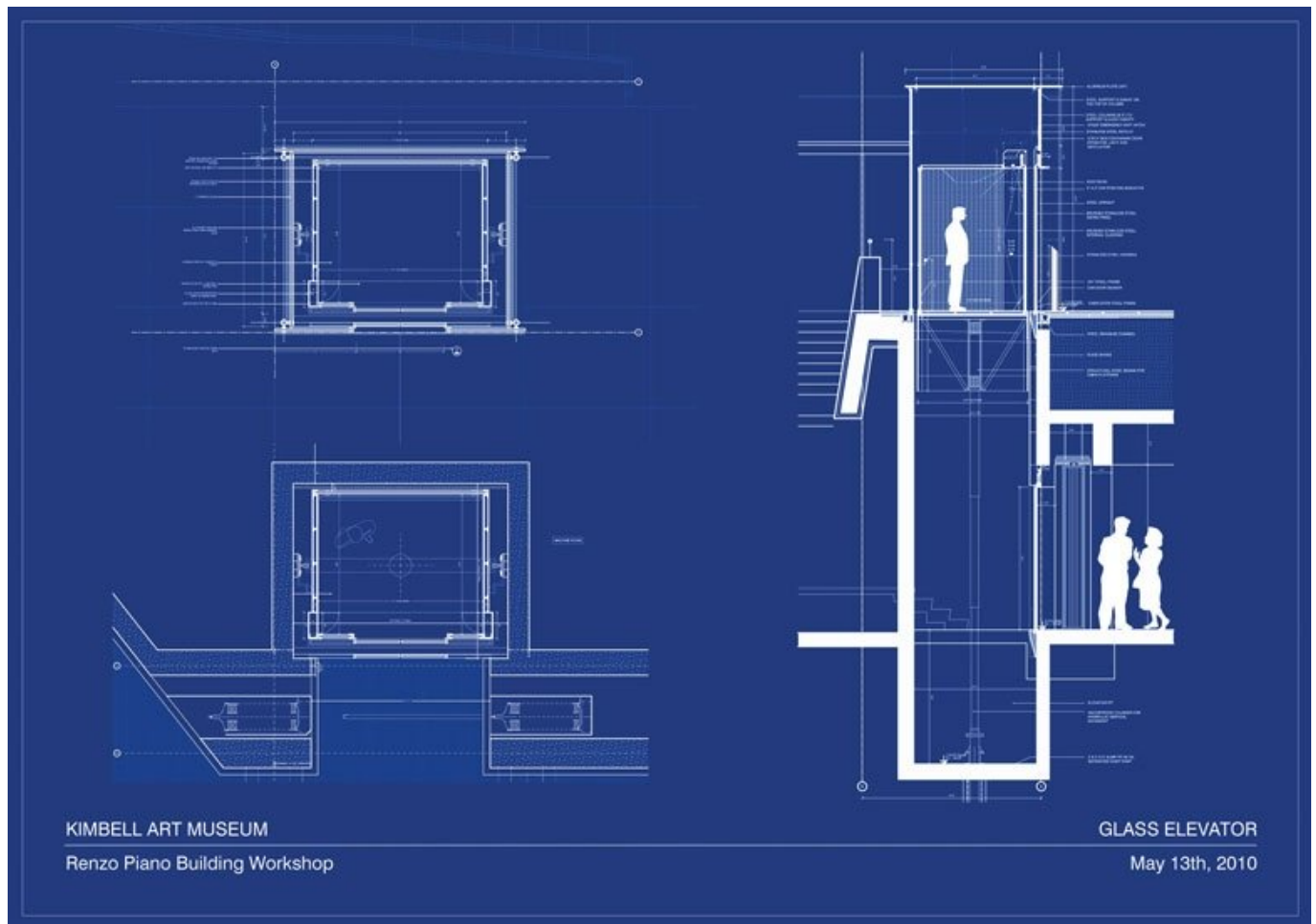

Titolo	Glass Elevator
Scala	NTS
Data	2010/05/13
Numero Disegno	-
Codice disegno	KAM_DW_310
Autore	Renzo Piano Building Workshop
Copyright	Renzo Piano Building Workshop

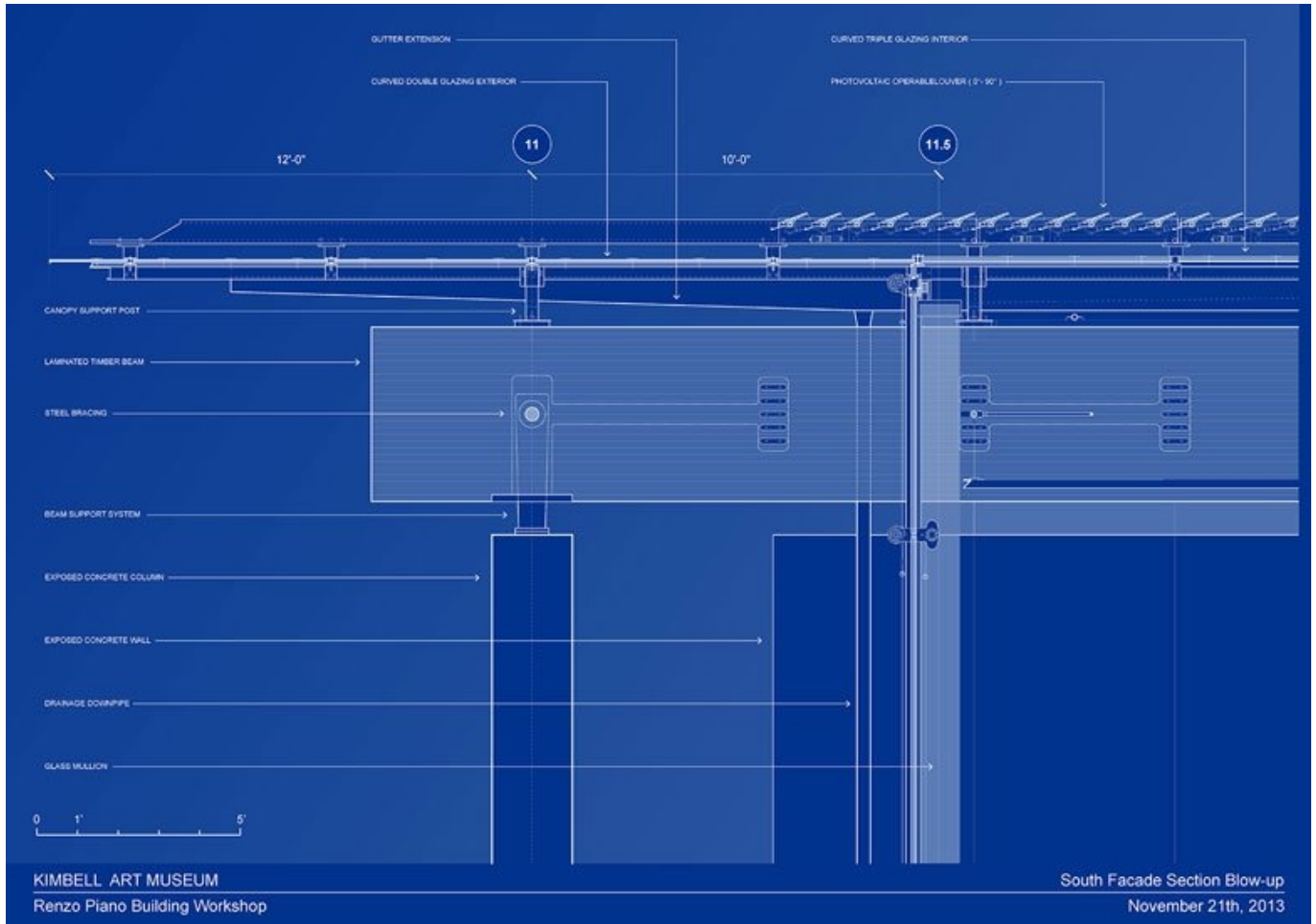

Titolo	South Facade Section Blow-up
Scala	NTS
Data	2013/11/21
Numero Disegno	-
Codice disegno	KAM_DW_311
Autore	Renzo Piano Building Workshop
Copyright	Renzo Piano Building Workshop

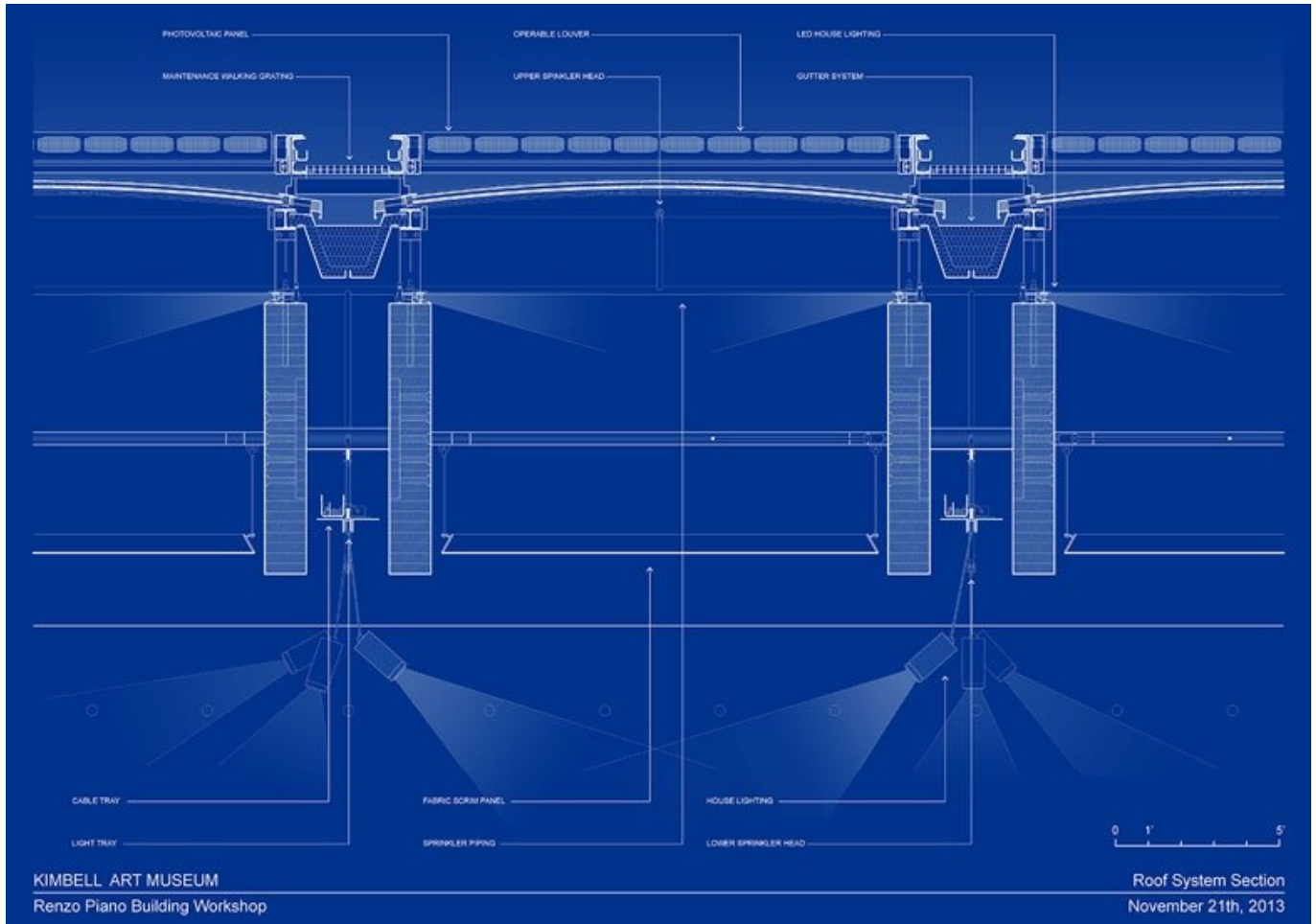

Titolo	Roof System Section
Scala	NTS
Data	2013/11/21
Numero Disegno	-
Codice disegno	KAM_DW_312
Autore	Renzo Piano Building Workshop
Copyright	Renzo Piano Building Workshop

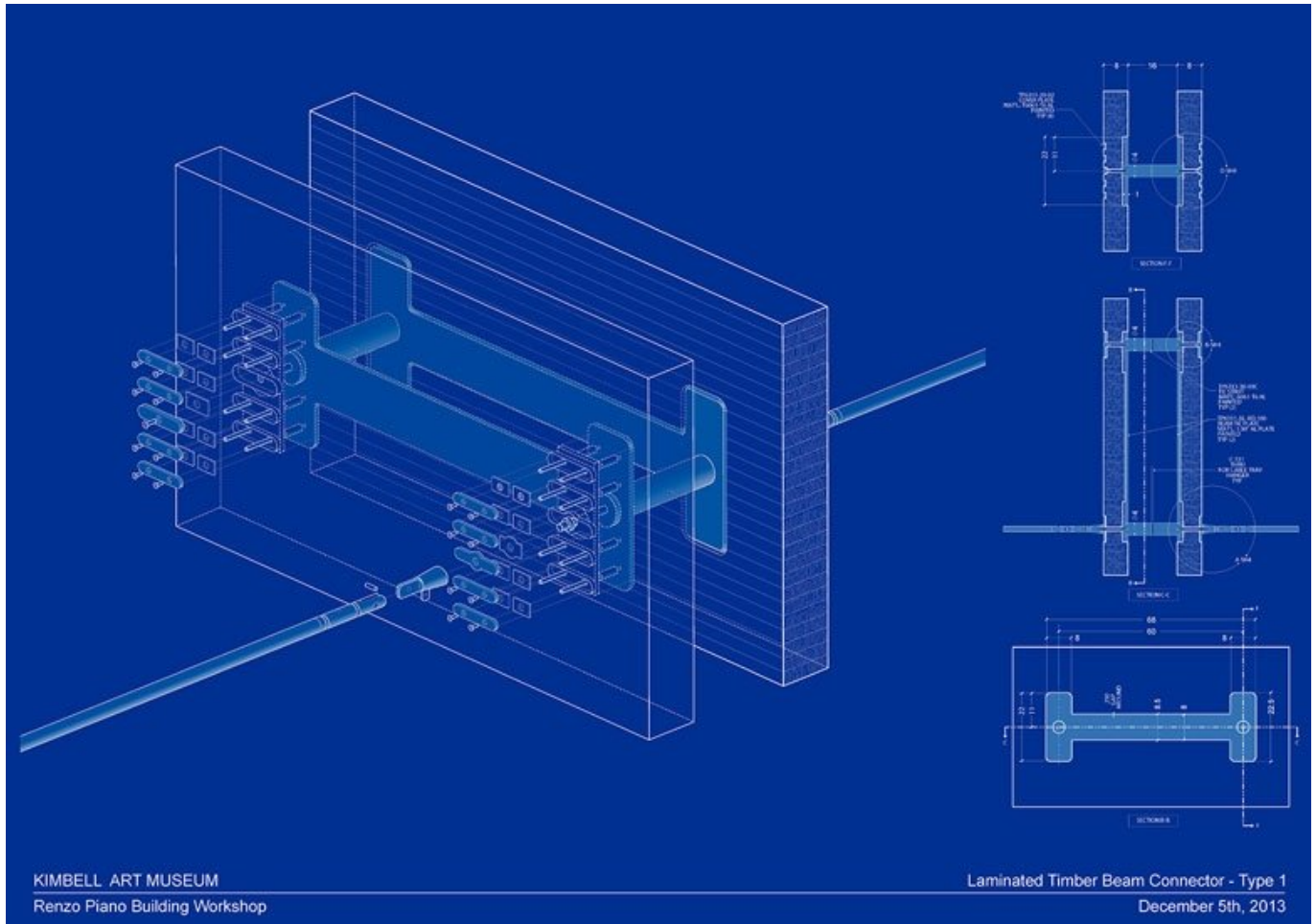

Titolo	Laminated Timber Beam Connector - Type 1
Scala	NTS
Data	2013/12/05
Numero Disegno	-
Codice disegno	KAM_DW_313
Autore	Renzo Piano Building Workshop
Copyright	Renzo Piano Building Workshop

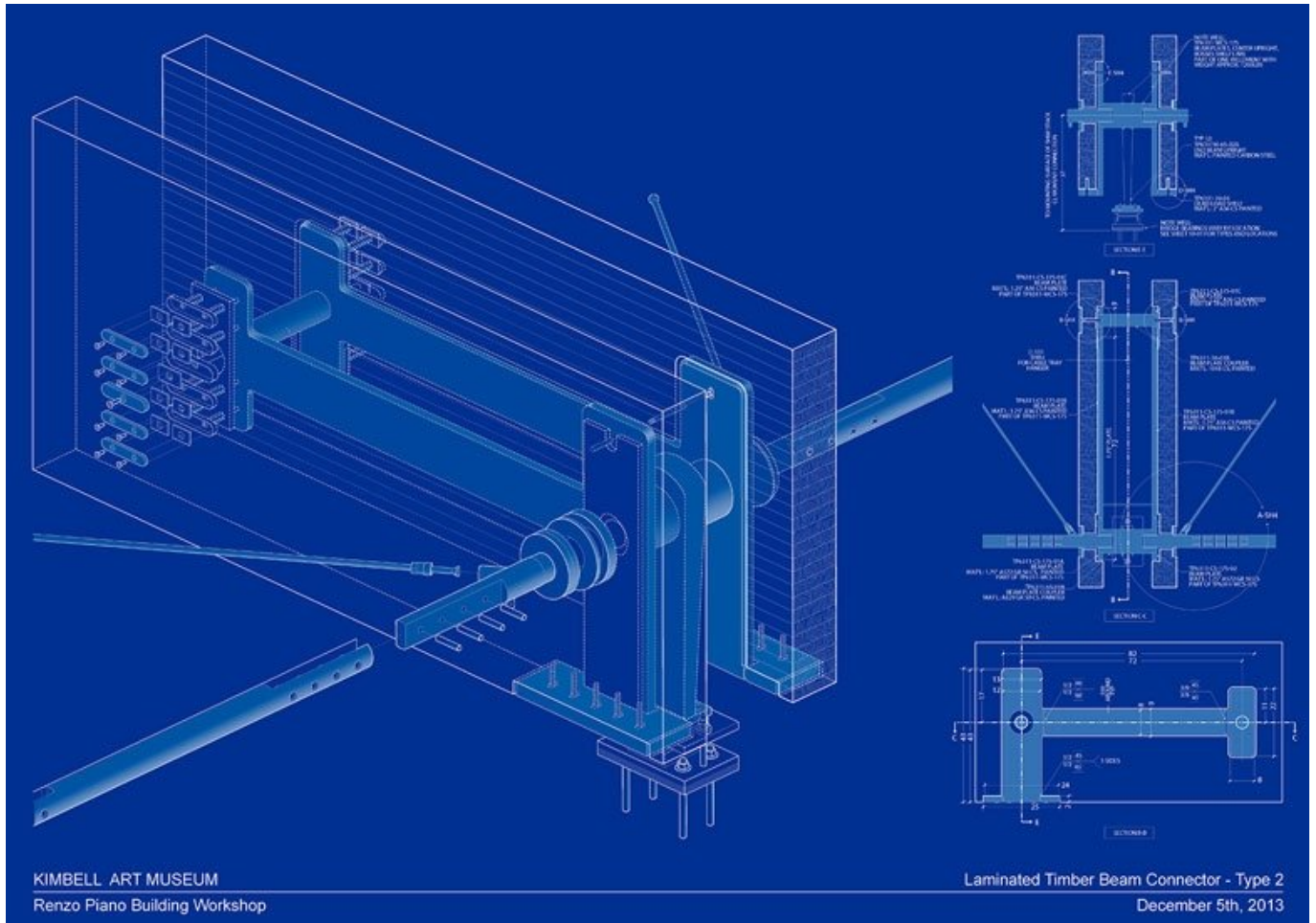

Titolo	Laminated Timber Beam Connector - Type 2
Scala	NTS
Data	2013/12/05
Numero Disegno	-
Codice disegno	KAM_DW_314
Autore	Renzo Piano Building Workshop
Copyright	Renzo Piano Building Workshop

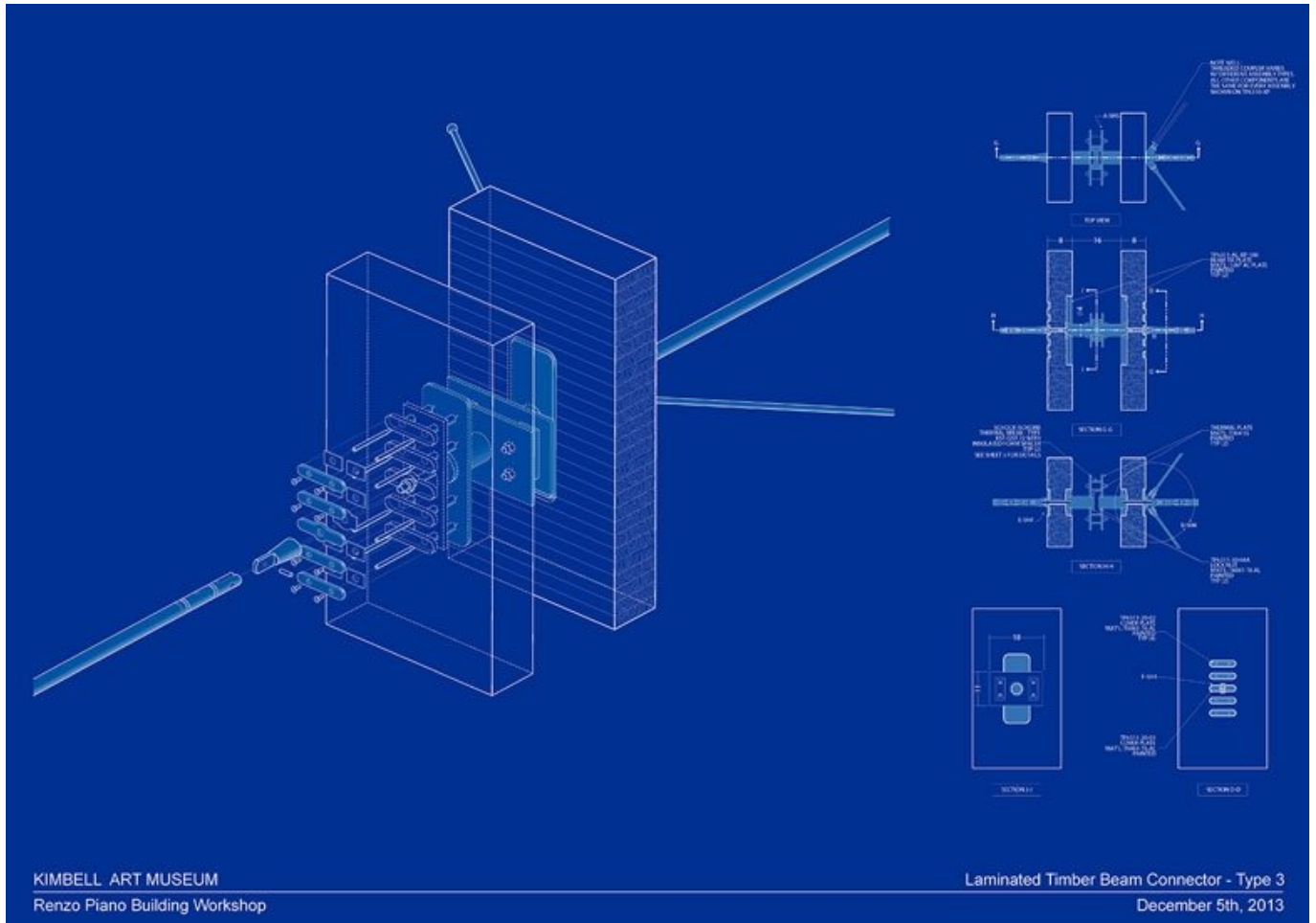

Titolo	Laminated Timber Beam Connector - Type 3
Scala	NTS
Data	2013/12/05
Numero Disegno	-
Codice disegno	KAM_DW_315
Autore	Renzo Piano Building Workshop
Copyright	Renzo Piano Building Workshop

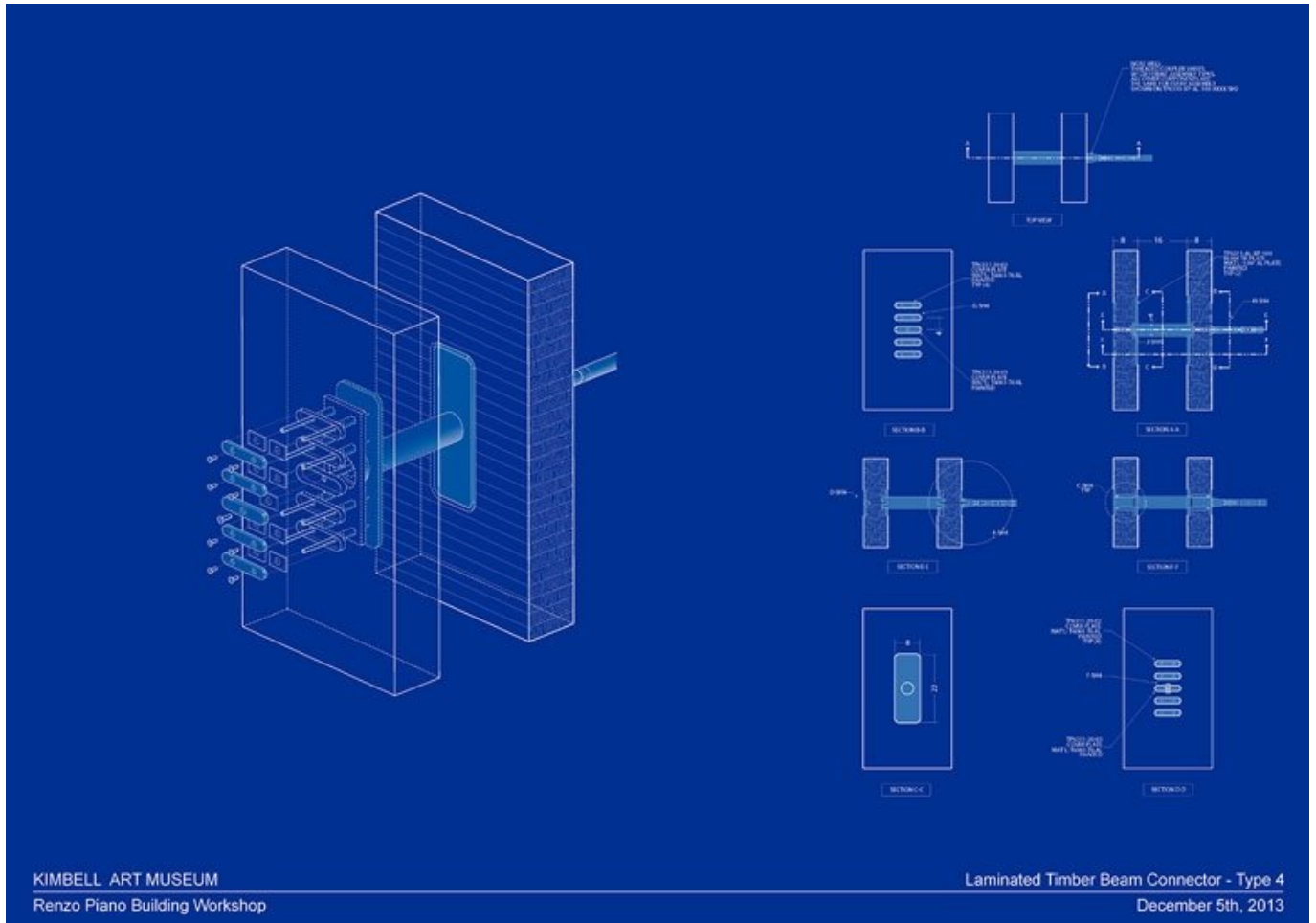

Titolo	Laminated Timber Beam Connector - Type 4
Scala	NTS
Data	2013/12/05
Numero Disegno	-
Codice disegno	KAM_DW_316
Autore	Renzo Piano Building Workshop
Copyright	Renzo Piano Building Workshop

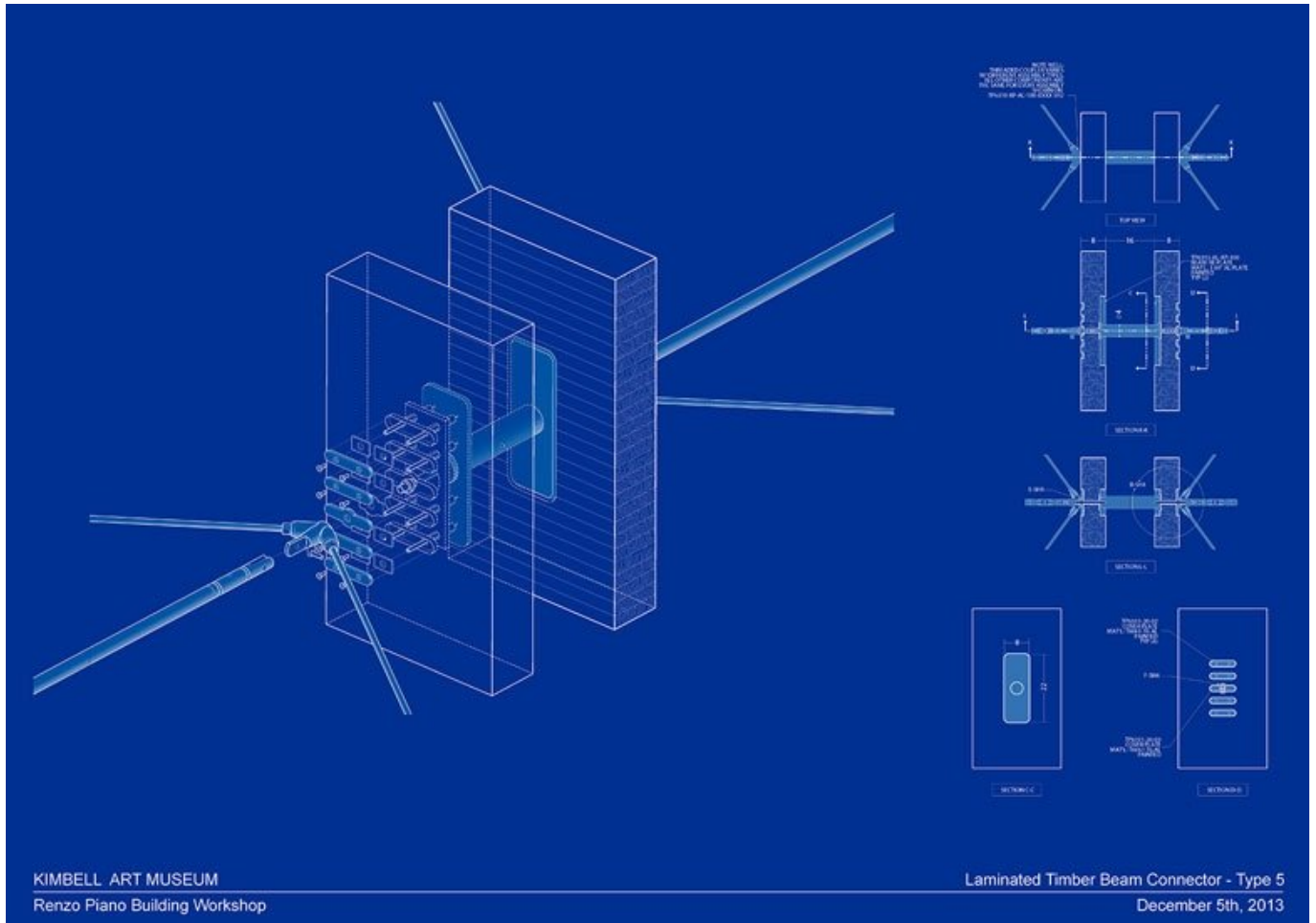

Titolo	Laminated Timber Beam Connector - Type 5
Scala	NTS
Data	2013/12/05
Numero Disegno	-
Codice disegno	KAM_DW_317
Autore	Renzo Piano Building Workshop
Copyright	Renzo Piano Building Workshop

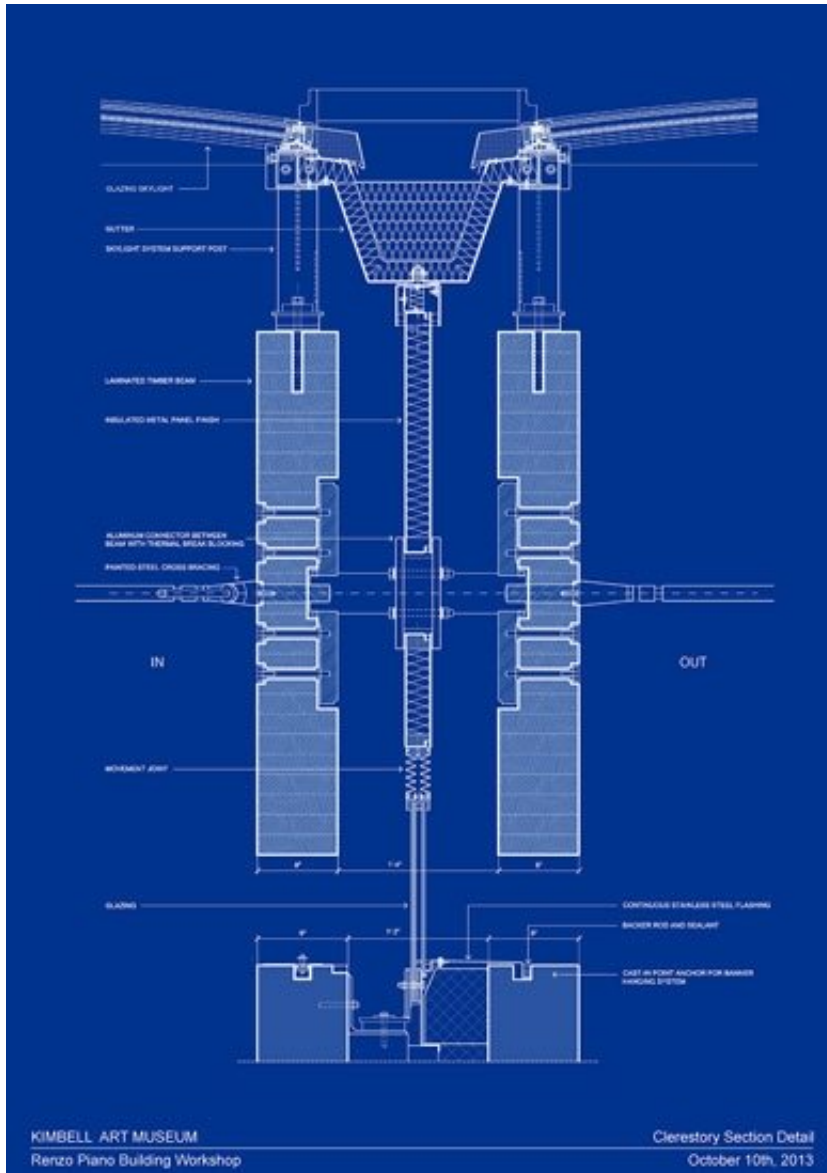

Titolo	Clerestory Section Detail
Scala	NTS
Data	2013/10/10
Numero Disegno	-
Codice disegno	KAM_DW_318
Autore	Renzo Piano Building Workshop

Copyright

Renzo Piano Building Workshop

Modelli

Titolo	Mock-up della facciata
Data	2011/10/07
Codice Modello	Kim_366
Scala	1/1"=1'-0"
Autore Modello	RPBW - Renzo Piano Building Workshop Architects

Titolo	Mock-up
Data	2010/04/09
Codice Modello	Kim__171
Scala	1/1"=1'=0"
Autore Modello	RPBW - Renzo Piano Building Workshop Architects



Titolo	Mockup dell'interno
Data	2011/12/17
Codice Modello	Kim_194
Scala	1/1"=1'=0"
Autore Modello	RPBW - Renzo Piano Building Workshop Architects

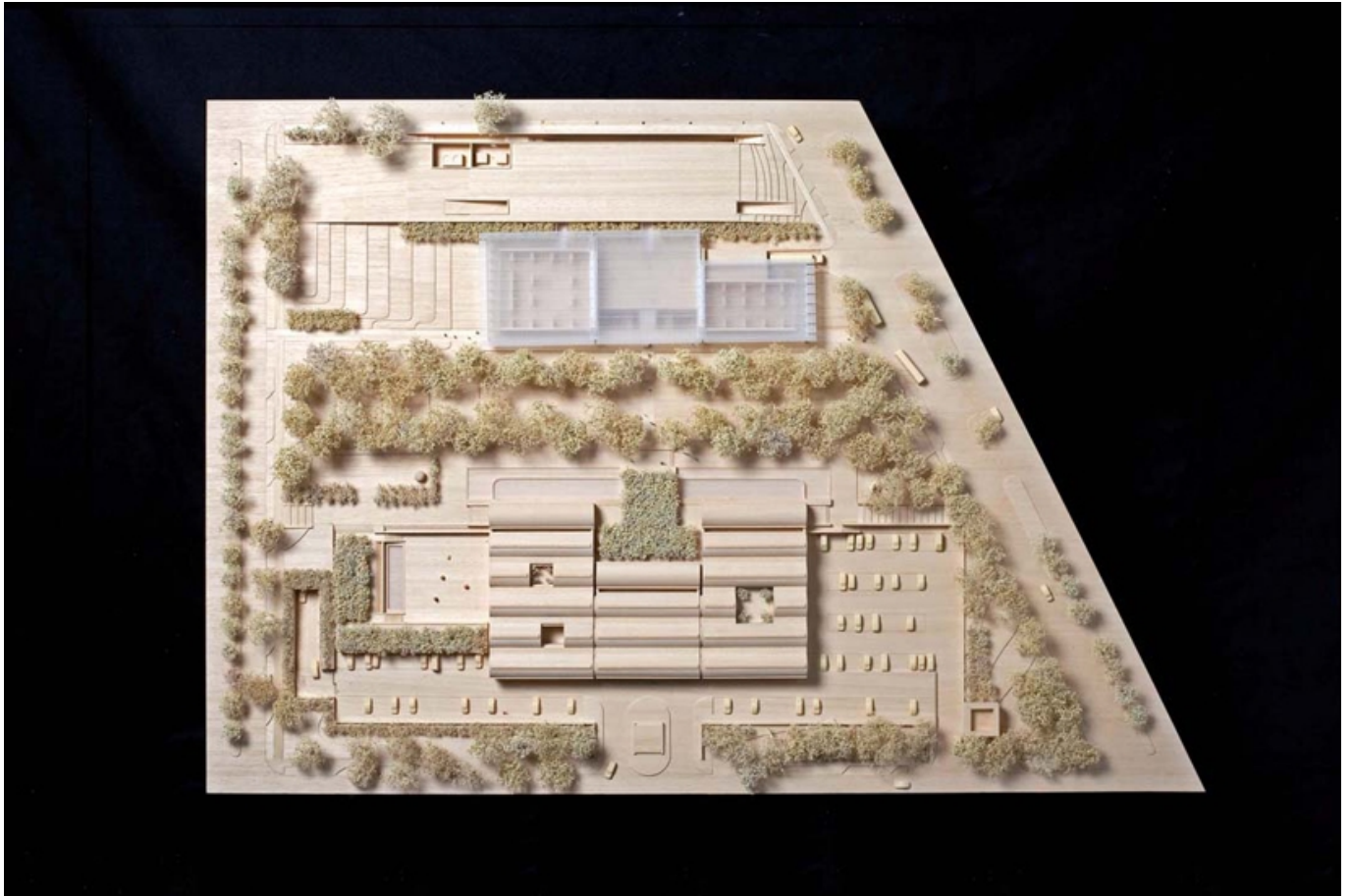

Titolo	Modello in legno del sito
Data	2009/04/28
Codice Modello	KAM_MD_159
Scala	1/64"=1'-0"
Autore Modello	RPBW - Renzo Piano Building Workshop Architects

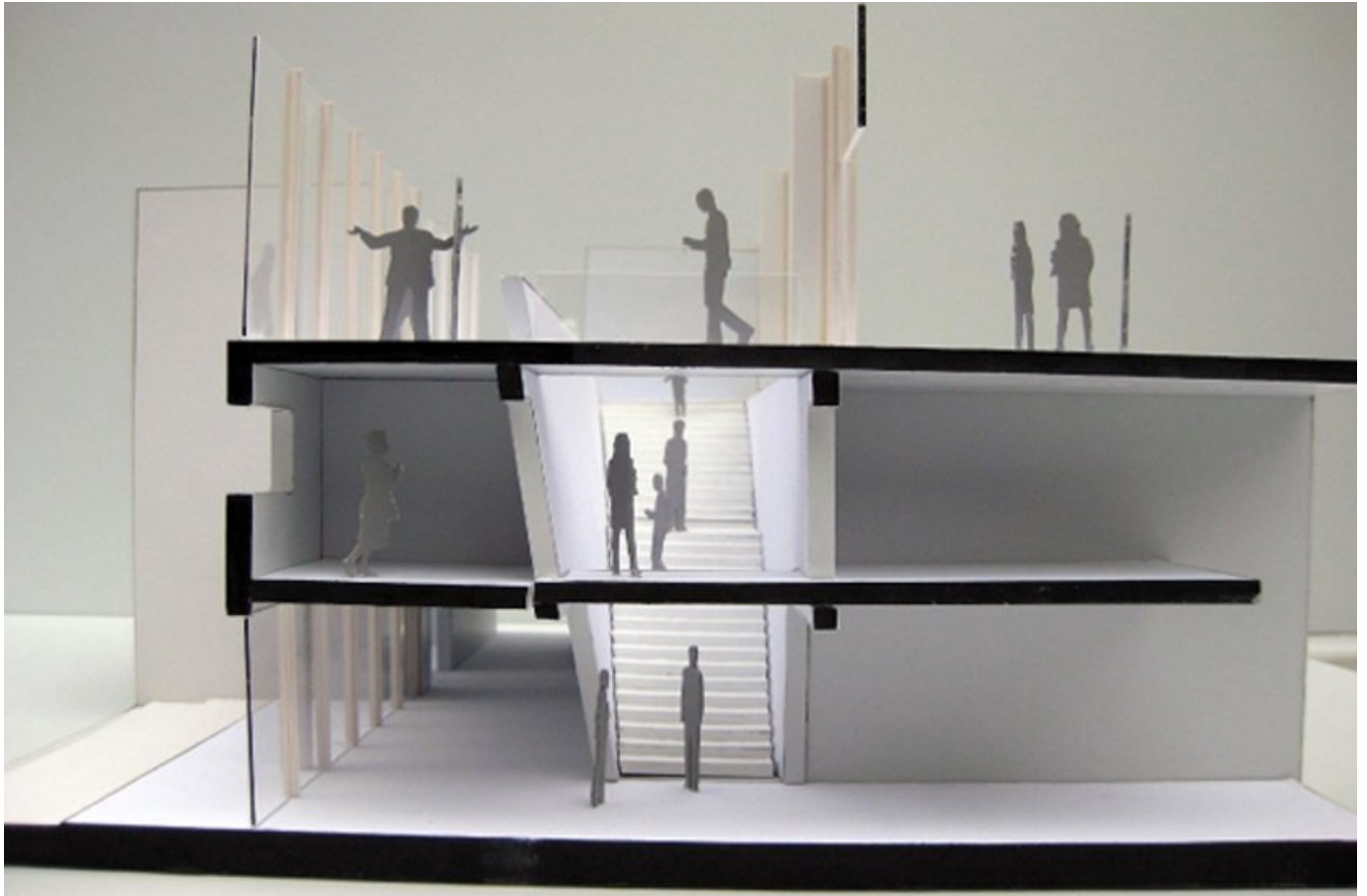

Titolo	Scale inclinate - Scala della hall dell'Auditorium
Data	2009/11/12
Codice Modello	KAM_MD_090
Scala	1/4"=1'-0"
Autore Modello	RPBW - Renzo Piano Building Workshop Architects

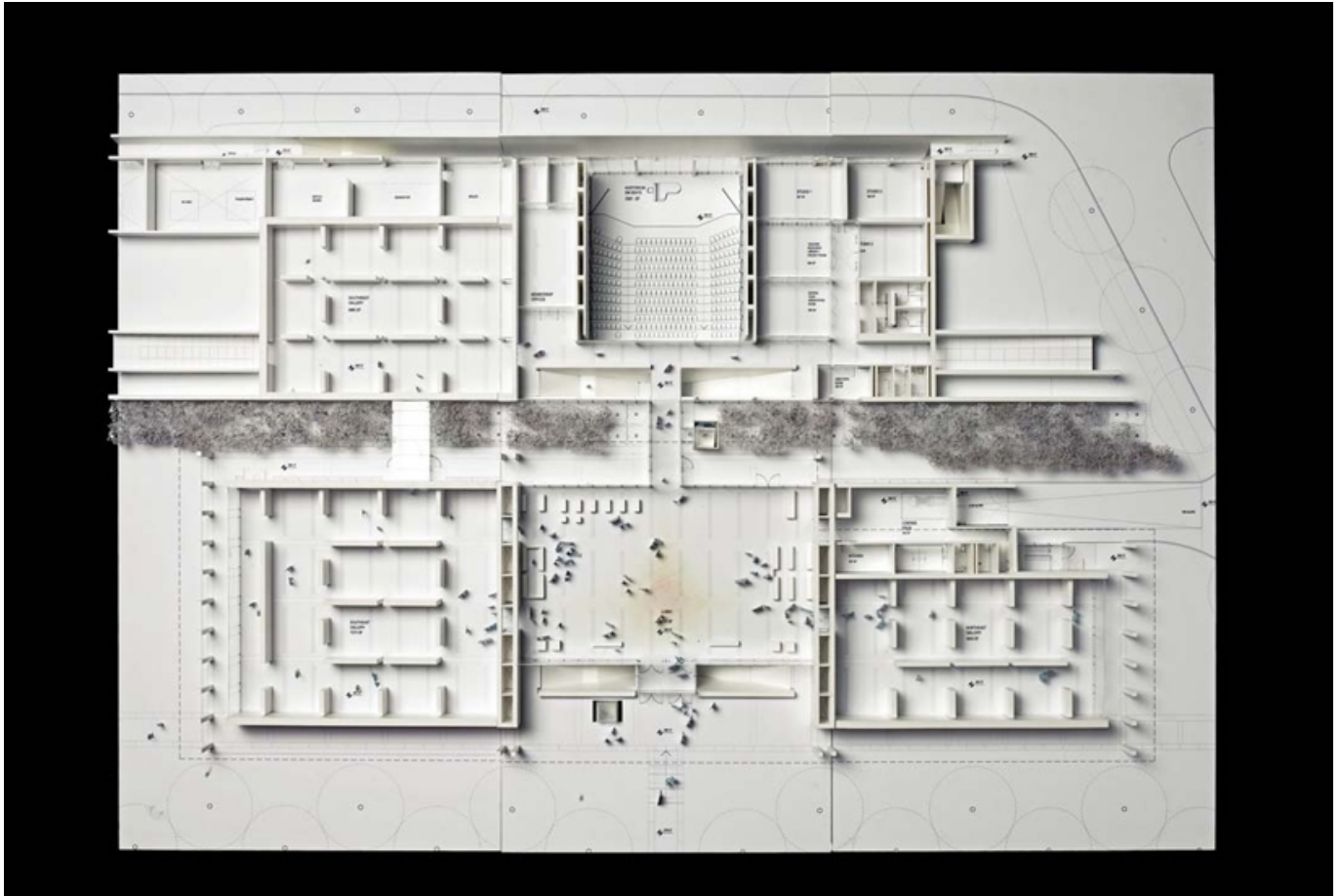

Titolo	Modello del museo di Kimbell (sud, centro, nord 1-2-3)
Data	2009/11/23
Codice Modello	KAM_MD_089
Scala	1/8"=1'-0"
Autore Modello	RPBW - Renzo Piano Building Workshop Architects

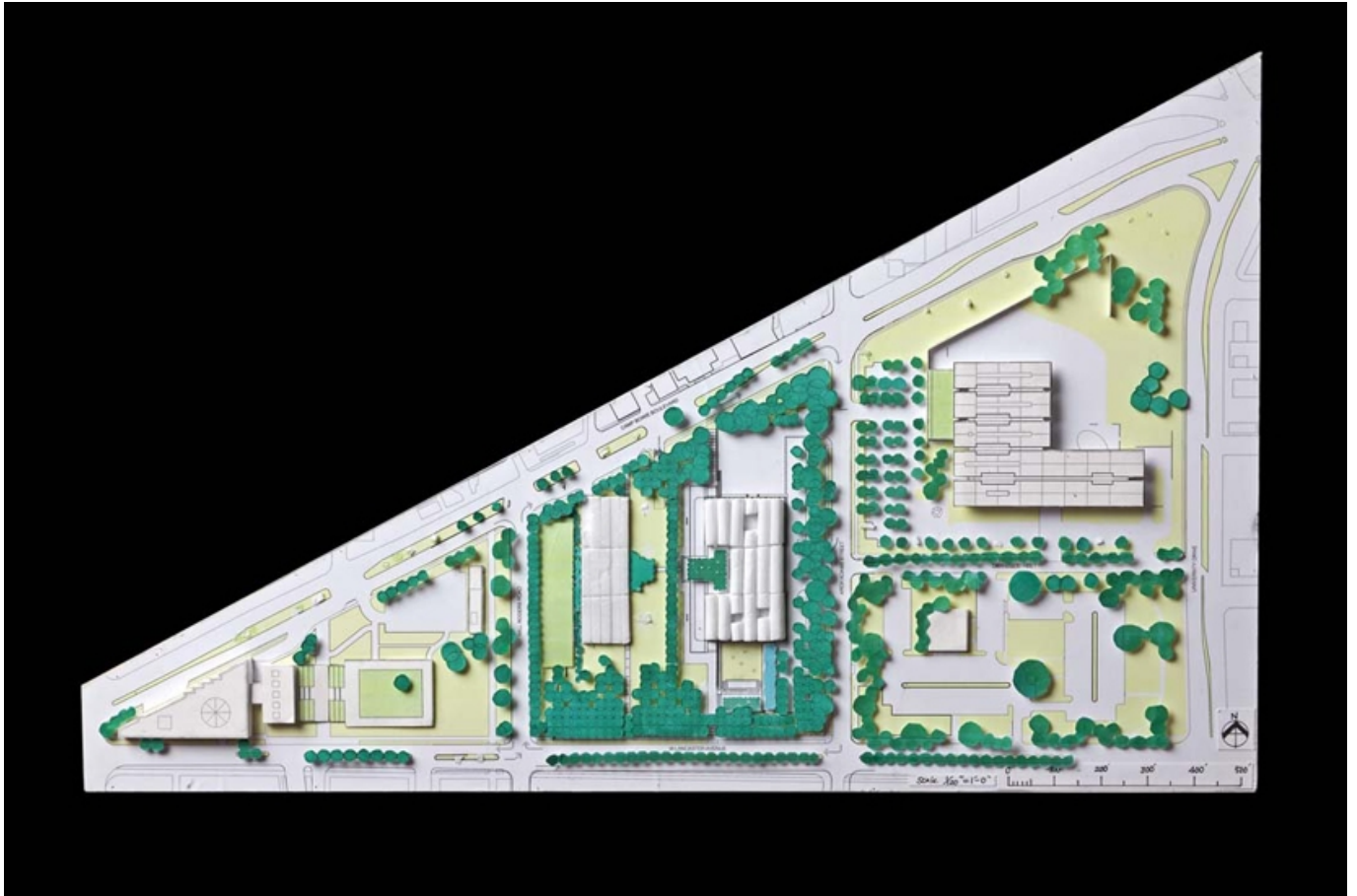

Titolo	Modello del sito
Data	2009/03/01
Codice Modello	KAM_MD_086
Scala	1/120"=1'-0
Autore Modello	RPBW - Renzo Piano Building Workshop Architects

